

Appendix 4.3-1

Geotechnical Report

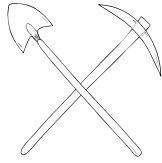

ALLAN E. SEWARD
ENGINEERING GEOLOGY, INC.

Geological And Geotechnical Consultants

GEOTECHNICAL REPORT
Review of CUP Exhibit A

Proposed New Sequoia Building
Union Rescue Mission – Hope Gardens
12249 Lopez Canyon Road
Sylmar, County of Los Angeles, California

Prepared for:

Union Rescue Mission
c/o Land Design Consultants, Inc.

Job No.: 20-2653-5
Dated: October 14, 2020

TABLE OF CONTENTS

1.0 SCOPE OF WORK.....	1
2.0 SITE DESCRIPTION	3
3.0 PROPOSED DEVELOPMENT.....	4
4.0 RESEARCH.....	4
5.0 FIELD INVESTIGATION, SAMPLING, AND LABORATORY TESTING	4
5.1 Subsurface Exploration.....	4
5.2 Field Infiltration Testing.....	5
5.3 Sampling Procedures	5
5.4 Laboratory Testing.....	6
6.0 GEOLOGIC AND GEOTECHNICAL CONDITIONS	6
6.1 Geologic Setting.....	6
6.2 Geologic Structure	7
6.3 Geologic Units	7
6.3.1 Saugus Formation (TQs).....	7
6.3.2 Quaternary Alluvium (Qal).....	7
6.3.3 Artificial Fill (af)	7
6.4 Ground Water.....	8
6.5 Infiltration Characteristics	8
6.5.1 Introduction.....	8
6.5.2 Reduction Factors	9
6.5.3 Results and Discussion	10
6.6 Soil Shear Strength	10
6.7 Soil Compressibility.....	11
6.8 Expansion Potential of Soils	11
6.9 Soil Corrosivity.....	11
7.0 SEISMIC CONSIDERATIONS	12
7.1 Introduction.....	12
7.2 Ground Rupture	12
7.3 Ground Motion.....	13
7.3.1 General.....	13
7.3.2 Earthquake Magnitude.....	14
7.3.3 Peak Ground Acceleration.....	15
7.3.4 Deaggregation of Fault Hazard.....	15
7.4 Ground Failure	16
7.4.1 Potential for Liquefaction and Associated Ground Failure	16
7.4.2 Potential for Other Modes of Ground Failure.....	18
8.0 GENERAL CONCLUSIONS AND GRADING RECOMMENDATIONS	18
8.1 Earthwork and Grading Recommendations	18

TABLE OF CONTENTS

8.1.1 Site Preparation.....	18
8.1.2 Removals	19
8.1.3 Preparation of Removal Bottoms.....	20
8.1.4 Fill Materials.....	20
8.1.5 Placement and Compaction of Fill Materials	20
8.1.6 Shrinkage and Bulking	20
8.1.7 Oversize Material.....	20
8.1.8 Rippability	21
8.1.9 Import Fill.....	21
8.2 Natural Slopes.....	21
8.3 Low Impact Development.....	21
8.4 Oil Wells and Water Wells	21
8.5 Sewage Disposal	22
8.6 Drainage.....	22
8.7 Landscaping.....	22
8.8 Planters.....	22
9.0 FOUNDATION RECOMMENDATIONS.....	23
9.1 Conventional Shallow Footing Foundations.....	23
9.1.1 Assumptions	23
9.1.2 Vertical Bearing Capacity Parameters.....	23
9.1.3 Settlement	23
9.1.4 Resistance to Lateral Loads	24
9.1.5 Auxiliary Structures.....	24
9.1.6 Additional Foundation Recommendations	24
9.2 Concrete Slabs-On-Grade	25
9.2.1 General.....	25
9.2.2 Slab Underlayment	26
9.3 Expansive Soils Considerations.....	26
9.4 Soil Corrosivity Considerations.....	27
10.0 CONVENTIONAL RETAINING WALLS	27
10.1 Assumptions.....	27
10.2 Footing Parameters	28
10.2.1 Vertical Bearing Capacity.....	28
10.2.2 Resistance to Lateral Loading	28
10.3 Lateral Earth Pressures	28
10.4 Retaining Wall Drainage.....	30
10.5 Retaining Wall Backfill	30
11.0 GROUND MOTION HAZARD ANALYSIS.....	31

TABLE OF CONTENTS

11.1 General.....	31
11.2 MCE _R Ground Motion Hazard Analysis.....	31
11.3 Design Response Spectrum and Acceleration Parameters.....	32
12.0 CONSTRUCTION CONSIDERATIONS.....	32
12.1 Excavations, Shoring, and Backfilling of Excavations.....	32
12.2 Utility Trench Backfill.....	32
12.3 Concrete Flatwork/Hardscape.....	33
13.0 TENTATIVE PAVEMENT DESIGN AND ASSOCIATED GRADING.....	33
13.1 Asphalt Concrete Pavements	33
13.2 PCC Vehicle Pavements	34
13.3 PCC Curb and Gutter.....	35
13.4 Base Course	35
13.5 Grading Recommendations for Pavement Construction.....	35
13.5.1 General.....	35
13.5.2 Subgrade Preparation.....	35
13.5.3 Placement of Base Materials	35
14.0 LOS ANGELES COUNTY 111 STATEMENT	36
15.0 PLAN REVIEW AND CONSTRUCTION OBSERVATIONS.....	36
16.0 GEOLOGIST/GEOTECHNICAL ENGINEER OF RECORD.....	37
17.0 LIMITATIONS.....	37

Location Map	following page 3
Geologic Map by Dibblee	following page 7
References	

APPENDIX A – Subsurface Logs and Infiltration Test Reports

- Exploratory Boring Logs (HS-1 thru HS-5)
 - Key to Boring Log Symbols
 - Boring Percolation Test Reports
- Figures A1 and A2

APPENDIX B – Laboratory Testing

APPENDIX C – Seismicity

- Earthquake Zones of Required Investigation
 - Fault and Earthquake Epicenter Location Map
 - OSHPD Seismic Design Maps Output
 - USGS Deaggregation Parameters and Output
 - Magnitude-Distance Contributions to Hazard
 - Site-Specific Response Spectra and Seismic Design Parameters
 - Ground Motion Hazard Analysis Calculations (4 pages)
 - Ground Motion and Response Spectra References
- Figure C1
Figure C2
Figure C3
Figure C4

TABLE OF CONTENTS

APPENDIX D – Liquefaction Evaluation

- SPT-Based Assessment of Seismic Soil Liquefaction Potential Figure D1
- Corrections for Standard Penetration Test (1 page)
- Seismic Soil Liquefaction Triggering Calculations (2 pages)
- Seismically-Induced Settlement Calculations (2 pages)
- References for Assessment of Liquefaction Potential and Estimated Cyclic Settlements

APPENDIX E – General Specifications, Figures, Map and Cross Sections

- Recommended Earthwork Specifications
- Recommended Specifications for Placement of Trench Backfill
- Drainage and Erosion Control Recommendations
- Retaining Wall Drainage Detail
- Alternate Retaining Wall Drainage Detail

Geotechnical Map

Plate I

Cross Sections 1-1' and 2-2'

Plate II

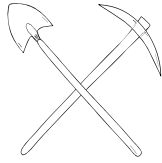

ALLAN E. SEWARD
ENGINEERING GEOLOGY, INC.
Geological And Geotechnical Consultants

October 14, 2020

Job No.: 20-2653-5

Union Rescue Mission
C/o Land Design Consultants Inc.
800 Royal Oaks Drive, Suite 104
Monrovia, CA 90061

Attention: Mr. Steve Hunter

Subject: **GEOTECHNICAL REPORT**
Review of CUP Exhibit A

Project: Proposed New Sequoia Building
Union Rescue Mission – Hope Gardens
12249 Lopez Canyon Road
Sylmar, County of Los Angeles, California

References: At end of text

Dear Mr. Hunter:

This report presents our opinions regarding the existing geologic and geotechnical conditions at the above-referenced site, their potential effects on the proposed development, and our geotechnical recommendations for design and construction.

1.0 SCOPE OF WORK

Our investigation included the following tasks:

1. Coordination with the project team.
2. Review of the CUP Exhibit “A” plan set (Sheets 1 thru 5) prepared by Land Design Consultants, Inc. (LDC), dated 8/3/2020. The 20-scale exhibit therein (Sheet 3) was used as the base for our Geotechnical Map (**Plate I**). We make no representation regarding the accuracy of this base map.
3. Review of pertinent geotechnical reports received from the County of Los Angeles for prior development at the project site.
4. Review of the published geologic reports and maps referenced at the end of this report.
5. Review of the Seismic Hazards Map and Report for the San Fernando Quadrangle.

6. Evaluation of ground water conditions and historic ground water levels based on Los Angeles County Flood Control District (LACFCD) water well data and published maps.
7. Coordination with Underground Service Alert to obtain clearance from potentially impacted utilities prior to the subsurface exploration.
8. Excavation, sampling and logging of 5 hollow-stem-auger borings (HS-1 through HS-5) drilled to a maximum depth of 37.5 feet, and 2 percolation borings (PB-1 and PB-2) drilled to a maximum depth of 12 feet.
9. Laboratory testing of samples obtained during our subsurface investigation.
10. Geotechnical evaluation of soil density, shear strength, compressibility, corrosion potential, expansion potential, and shrinkage and bulking factors.
11. Evaluation of feasibility of on-site stormwater infiltration.
12. Performed general earthquake ground motion characterization utilizing the latest seismic ground-motion provisions of the 2019 California Building Code (CBC), ASCE 7-16, and Special Publication 117A. Our evaluation included calculation of site-specific response spectrum parameters and potential ground accelerations that could be generated at the site during future earthquakes on nearby faults.
13. Assessment of potential ground rupture hazard at the site.
14. Geotechnical assessment of liquefaction potential of site alluvial soils and calculation of associated seismic settlements and lateral spread displacements based on subsurface data, existing and historic ground water levels, laboratory test results, and estimated earthquake ground motions.
15. Estimation of potential static settlements under future building loads based on SPT blow count data and the results of our laboratory testing.
16. Evaluation of geotechnical parameters for design of shallow footing foundations, retaining walls and slab-on-grade floors, including allowable bearing pressure, equivalent fluid densities for calculation of active, passive, and at-rest pressures, soil to concrete friction factors, and coefficient of subgrade vertical reaction beneath floor slab areas.
17. Assessment of recommended grading removal depths based on subsurface conditions, calculated seismic settlements, and estimated static settlements under assumed future building loads.

18. Preparation of the enclosed Geotechnical Map (**Plate I**) illustrating our geologic and geotechnical data and recommended mitigation measures in relation to the proposed improvements.
19. Preparation of Cross Sections 1-1' and 2-2' (**Plate II**) illustrating anticipated geotechnical conditions with respect to the proposed structure.
20. Preparation of figures and illustrations, including Location Map, Fault Location Map, drill hole logs, laboratory test reports, infiltration test reports, seismicity figures, liquefaction and lateral spreading results and calculations, and pertinent construction details for inclusion in this report.
21. Preparation of this Geotechnical report, which summarizes the results of our investigation and provides geotechnical recommendations for design and construction of the proposed development, for submittal to the Los Angeles County Department of Public Works, Geotechnical and Materials Engineering Division.

2.0 SITE DESCRIPTION

The project site is located on the west side of Lopez Canyon Road within the northeasterly trending Lopez Canyon, in the northern part of Sylmar in unincorporated Los Angeles County (see **Location Map** following page 3). The sprawling property is occupied by various, isolated residential, office, and maintenance buildings, access roads, parking lots, and gardens operated by Union Rescue Mission and referred to as their Hope Gardens campus. The campus is situated in the alluvial canyon bottom with mature landscaping that consists of large oaks, evergreens, and palms, non-native grasses and various flora, fauna, and shrubs. The property gently falls down-canyon toward the south over approximately 1700 ft, with elevations that range from 1365 to 1440 ft above MSL.

In general, the property is bounded by undeveloped areas on the upstream (north) and downstream (south) sides and flanked by bedrock ridgelines to the east and west. The existing one-story residential Sequoia building is the northernmost structure on the campus, situated at an approximate elevation of 1420 ft. At this location, the site is bounded by Lopez Canyon Road on the easterly side and an open concrete drainage culvert on the west side (at the toe of the ascending canyon slope). A small armored drainage channel extends down-canyon on the easterly side, between the existing Sequoia building and Lopez Canyon Road. It is presumed that this channel directs sheet flow of stormwater emanating from the relatively flat, open area directly to the north away from the building. Both drainage channels were observed to be dry during the site investigation.

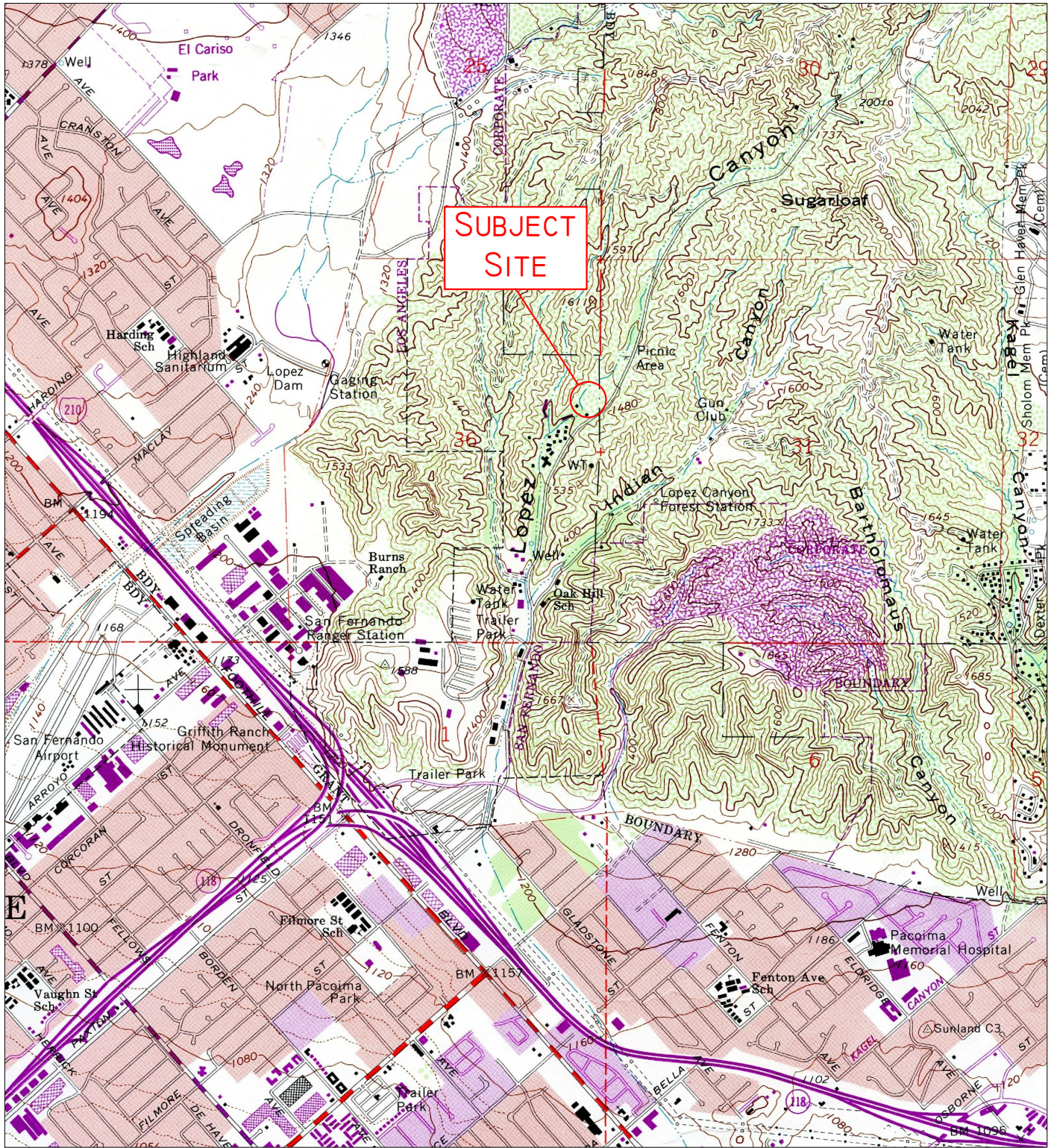

SOURCE: USGS SAN FERNANDO QUADRANGLE, DATED 1966, PHOTO REVISED 1988

APPROXIMATE SCALE: 1"=2,000'

NOTE: THIS IS NOT A SURVEY OF THE PROPERTY

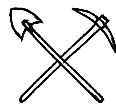

ALLAN E. SEWARD
ENGINEERING GEOLOGY, INC.
 Geological And Geotechnical Consultants

LOCATION MAP

JOB No.: 20-2653-5

DATE: 10/14/20

3.0 PROPOSED DEVELOPMENT

The proposed development includes demolition of the existing 2-story Sequoia building and replacement with a new 4-level building (including a partial subterranean level), retaining walls (up to 10 ft in height), hardscape, vehicle pavement and parking lot improvements, and stormwater quality control measures. Up to about 6 feet of compacted fill will be placed to achieve first-floor subgrade elevations; subgrade elevation for the subterranean level is estimated at approximately 6 to 8 feet beneath existing grade.

Preliminary foundation plans and details are not available at this time; however, based on the data and results presented herein it is assumed that the proposed structure will be supported on conventional footing foundations with concrete slab-on-grade. For this study we have assumed isolated column loads up to 300 kips and wall loads up to 5 kips per linear foot.

4.0 RESEARCH

Records were requested from the Los Angeles County Department of Public Works, Geotechnical and Materials Engineering Division (GMED) relative to prior site development. A digital copy of the Foundation Investigation report prepared by Foundation Engineering Co., Inc., dated 12/7/74 (see Reference 1), and various Los Angeles County geologic review sheets were provided. The referenced report dated 12/7/74 was reviewed as part of the current study. Supplemental geologic reports dated 2/28/75 and 5/1/75 that were indicated on a review sheet dated 5/7/75 were not available. No significant findings were made based on this research.

5.0 FIELD INVESTIGATION, SAMPLING, AND LABORATORY TESTING

5.1 Subsurface Exploration

Subsurface exploration performed to address the proposed new building included the drilling, sampling, and logging of five (5) hollow-stem auger borings (HS-1 thru HS-5) to a maximum depth of 37.5 feet. The borings were drilled by Choice Drilling Inc. and logged by the undersigned Geotechnical Engineer on 8/27/20 and 8/28/20.

The drill hole logs are included in **Appendix A** and represent our interpretation of field data prepared for each boring by our geologic/engineering staff at the time of drilling, along with refinements based on observations and laboratory test results. Unit boundaries shown in the graphic log column of our hollow-stem-auger drill hole logs are approximate and may represent gradual transitions. The boring locations are shown on the attached Geotechnical Map (**Plate I**).

5.2 Field Infiltration Testing

Two (2) additional hollow-stem auger borings (PB-1 and PB-2) were excavated to a depth of 12 feet in the vicinity of hollow-stem auger borings HS-4 and HS-5, respectively, to evaluate the use of Low Impact Development (LID) stormwater quality control measures with an infiltration component. Field infiltration testing was conducted using the “Boring Percolation” test procedure outlined in Administrative Manual GS200.2 (dated 6/30/17), *Guidelines for Investigation and Reporting, Low Impact Development Stormwater Infiltration*, prepared by the County of Los Angeles Department of Public Works, Geotechnical and Materials Engineering Division (referred to herein as GMED LID Guidelines). The infiltration testing was performed as described below:

- At each location an 8-inch diameter borehole was excavated to a target invert elevation of 12 feet below existing grade using a hollow-stem-auger drill rig.
- A water delivery pipe with end cap was installed in the borehole to introduce water during the test. The water delivery pipe consisted of 2-inch diameter Schedule 40 PVC pipe, with Schedule 40 PVC slotted well screen in the lower 1.5 feet.
- A separate pipe was installed to monitor the water level during the test. This pipe consisted of 2-inch diameter Schedule 40 PVC pipe, with Schedule 40 PVC slotted well screen in the lower 5 feet.
- Following installation of the pipes, the annular space was backfilled with No. 2 filter pack material to at least 6 inches above the slotted section of the water delivery pipe.
- Clear water was introduced into the boreholes using flexible tubing connected to a 13,000 mL graduated cylinder. The boreholes were filled to a water level 2 feet above the bottom of the borehole. A ball valve on the flexible tubing was used to maintain a constant head of 2 feet above the bottom during the test period.
- After the initial filling and 1-hour pre-soak period, a ball valve on the flexible tubing was used to maintain a constant head elevation of 2 feet above the borehole bottom during the test period. The volume of water required to maintain the constant head was recorded using the graduated cylinders at 10-minute intervals until the flow rate stabilized.

Results of field infiltration testing are discussed in **Section 6.5** of this report.

5.3 Sampling Procedures

California drive (relatively undisturbed) ring and Standard Penetration Test (SPT) samples were obtained in the exploratory drill holes at various depths (see logs in **Appendix A**). Recovered soil samples were sealed in plastic containers and brought to our laboratory for

further classification and testing.

Bulk (disturbed) samples of the near surface soils were obtained from cuttings developed during excavation of the exploratory drill holes. The bulk samples were collected for classification and testing purposes and represent a mixture of soils within the noted depths.

5.4 Laboratory Testing

Soil samples were visually classified at the site in accordance with the Unified Soil Classification System (ASTM D2487). Thereafter, the samples were brought to our geotechnical laboratory, the visual soil classifications were checked, and the trench logs were reviewed in order to select soil samples for testing.

The laboratory testing program performed on samples of on-site soils included the following tests: moisture content, dry density, percent minus no. 200 sieve (i.e., percent fines), particle-size analysis, hydro-compression, direct shear, Modified Proctor (compaction), and corrosivity (sulfate content, chloride content, pH, and resistivity).

Laboratory test methods and results of the testing are provided in **Appendix B** of this report.

6.0 GEOLOGIC AND GEOTECHNICAL CONDITIONS

6.1 Geologic Setting

The project site is located at the mountain front (south side) at the west end of the San Gabriel Mountains, just above the San Fernando Valley, in the Transverse Ranges geomorphic province of southern California. At this location, the east-west trending San Gabriel Mountains consist predominately of intrusive igneous rocks of granodiorite and quartz diorite that are being thrust over the subsiding San Fernando basin from the north. Prominent structural features include a series of north-dipping thrust faults that comprise the San Fernando section of the Sierra Madre Fault Zone, located 0.5 miles to the south of the site.

Pleistocene Saugus Formation (TQs) is widely distributed along the mountain front in the vicinity of the project site and rests unconformably upon the Pico Formation and Towsley Formation, and unconformably overlies or is in fault contact with the igneous and metamorphic basement rocks. The Saugus Formation generally is comprised of nonmarine interbedded light gray pebble-cobble conglomerate, sandstone, and greenish to reddish claystone (Dibblee, 1991).

Large canyon drainages with source areas in the steep, rugged San Gabriel Mountains, including Big Tujunga Canyon and Pacoima Canyon, extend south to the San Fernando Valley. The project site, located in Lopez Canyon, drains an area between these two larger canyons where the bedrock has been uplifted on the hanging wall of the San Fernando fault.

Deposits in Lopez Canyon include young sands and gravelly sands with potential for large cobbles and boulders.

6.2 Geologic Structure

Bedrock at the project site has been uplifted and tilted by north-south compressional tectonic forces producing geologic structures which trend east-west (see **Geologic Map by Dibblee** following page 7). The Saugus Formation bedding generally strikes east-west and dips 53 to 60° to the north (Dibblee, 1991).

6.3 Geologic Units

The project site consists of recent alluvial sedimentary deposits (Qal) within Lopez Canyon that are underlain by Saugus Formation (TQs) bedrock. Saugus Formation bedrock is also exposed in the adjacent ridgelines. Artificial fill (af) associated with past site development was encountered at one subsurface location to a depth of 6 feet. In general, the artificial fill is considered to be thin (< 3 feet) and is undifferentiated from the alluvium. Details of the geologic units observed at the site are discussed below and presented on our subsurface logs (**Appendix A**).

6.3.1 Saugus Formation (TQs)

Bedrock underlying the alluvial deposits was encountered at depths ranging from 23 ft at boring HS-1 to 32.5 ft at boring HS-4. The bedrock observed consists of light brownish-gray, medium-brown and pale yellowish-brown, very dense, damp silty sandstone and brown, reddish-brown, and light brownish-gray, hard, damp sandy mudstone.

6.3.2 Quaternary Alluvium (Qal)

Unconsolidated alluvial deposits predominantly consist of interbedded, light to dark brown, yellowish-brown, and dark brownish-gray, medium dense to very dense, fine- to coarse-grained sand and silty sand with gravel. Interbedded layers of silty and clayey sands were also observed in boring HS-1. Resistant layers, presumed to be due to the presence of cobbles, were encountered in borings HS-1 at 25 ft, HS-2 from 20 to 25 ft, HS-3 at 15 ft, and HS-4 from 7 to 11 ft. Measured in-situ dry densities in the alluvium range from about 109 to 126 pcf with moisture contents that range from 1.4 to 11.4 percent.

6.3.3 Artificial Fill (af)

Artificial fill (af) generated from past development activities was encountered in boring HS-1 and was observed to a maximum depth of about 6 feet. The artificial fill consisted of light-brown and dark-gray, poorly graded sand with silt and gravel. The fill is characterized as dense to very dense and moist but is undocumented fill and not considered suitable for support of structures due to potential variability in strength and composition.

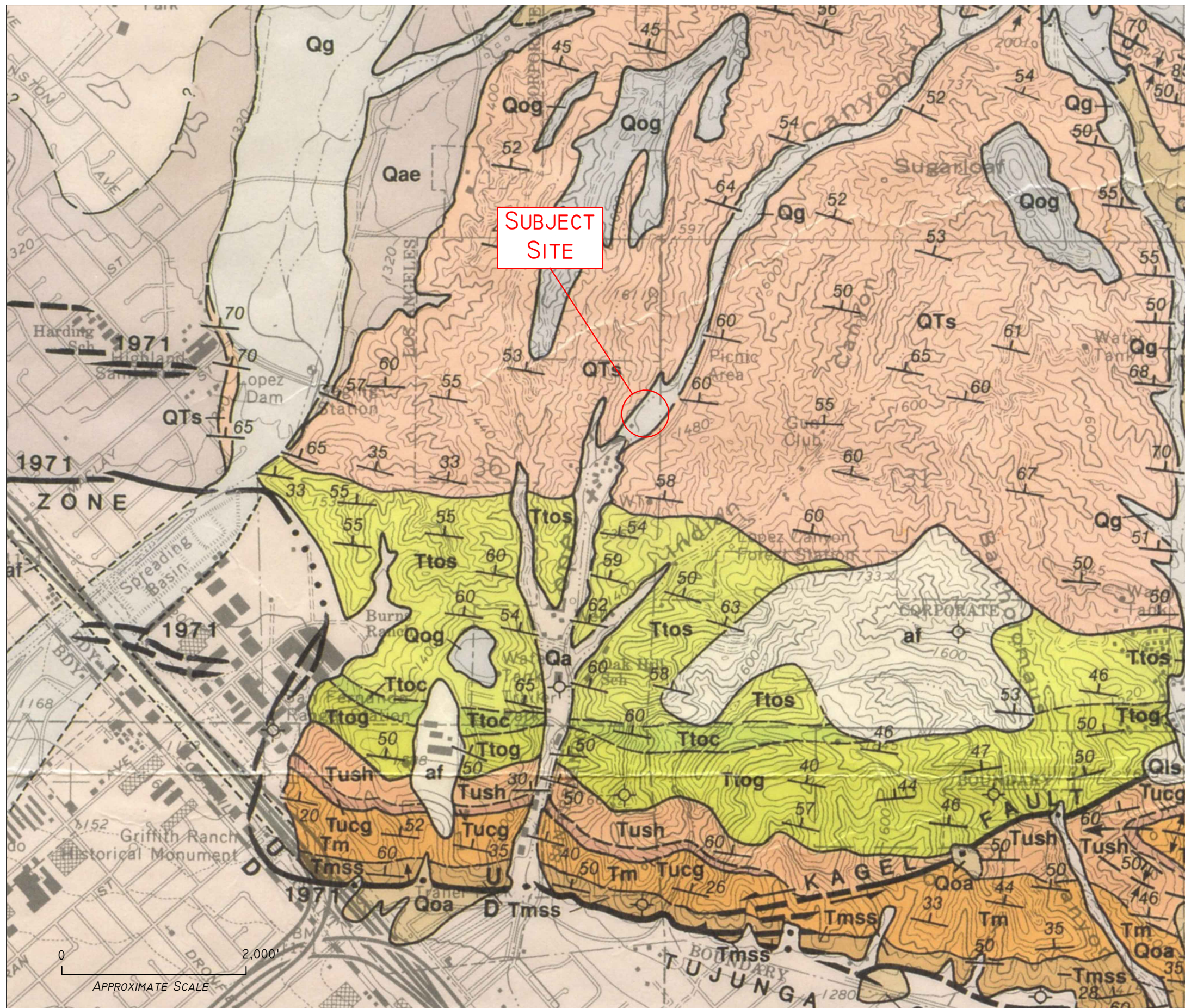

LEGEND

SURFICIAL SEDIMENTS		
Qg gravel and sand of major stream channels		
Qa alluvial gravel, sand and clay of valley areas		
Qls landslide debris		
OLDER DISSECTED SURFICIAL SEDIMENTS		
Qae similar to Qa, but slightly elevated and dissected		
Qoa remains of older, slightly consolidated, dissected alluvial gravel and sand		
Qog high remnants of slightly consolidated, brown coarse alluvial gravel		
— UNCONFORMITY —		
PACOIMA FORMATION (of Oakeshott 1958)		
terrestrial, weakly consolidated; Pleistocene age		
Qp weakly consolidated brown alluvial gravel and sand derived from adjacent mountains		
— UNCONFORMITY —		
SAUGUS FORMATION		
terrestrial, weakly consolidated; Pliocene and Pleistocene age		
QTa light gray pebble-cobble conglomerate, sandstone and greenish to reddish claystone, interbedded; composed of locally derived granitic and gneissic detritus including some of anorthosite and gabbro-norite, deposited by streams; Pliocene and Pleistocene age		
Tt (in Whitney Canyon area) same as QTa, but correlative in age (Pliocene) with units Tsr and Tps (in part lower member of Pico Formation of Oakeshott 1958)		
Tsr Sunshine Ranch Member (of Oakeshott 1958; Winters and Durham 1962, in part) in Van Norman Lake area; light reddish to greenish claystone and sandstone and interbedded pebble-cobble conglomerate similar to that of QTa		
TOWSLEY FORMATION (of Winters and Durham 1962; Pico Formation of Hill 1930; "Repetto" Formation, including Elsmere Member, of Oakeshott 1958)		
terrestrial and shallow marine regressions; latest Miocene and/or early Pliocene age		
Ttos mostly light gray to tan sandstone; minor gray silty claystone and conglomerate		
Ttoc gray silty claystone and siltstone, minor sandstone		
Ttlog gray to brown crudely bedded cobble conglomerate of mostly granitic and gneissic detritus and coarse grained sandstone; probably terrestrial, deposited by streams as a fan-delta		
— UNCONFORMITY — in mountain area		
UNNAMED MARINE STRATA (included in Modelo Formation by Oakeshott 1958; Barrows et al. 1974; probably equivalent to Siqoc Formation of Ventura Basin)		
marine clastic; probably late Miocene age		
Tush light gray, bedded, clayey to slightly siliceous, crumbly shale		
Tucg brown cobble conglomerate of granitic, some basaltic-andesitic detritus, and sandstone		
Tm white-weathering, thin bedded, hard, platy to soft, fissile, semi-siliceous shale		
Tmss light gray to tan bedded sandstone; gritty or pebbly with granitic detritus		
CASTAIC FORMATION (north of San Gabriel Fault; only lowest part exposed in quadrangle)		
marine clastic and biogenic; late Miocene age		
Tca light gray to tan crudely bedded diatomaceous or semi-siliceous claystone or siltstone, somewhat crumbly; thin sandstone at base		
— UNCONFORMITY —		
MONTEREY FORMATION (Modelo Formation of Oakeshott 1958; Barrows et al. 1974)		
marine biogenic and clastic; late Miocene age (Molnisan Stage)		
Tm white-weathering, thin bedded, hard, platy to soft, fissile, semi-siliceous shale		
Tmss light gray to tan bedded sandstone; gritty or pebbly with granitic detritus		
MINT CANYON FORMATION (north of San Gabriel Fault)		
nonmarine clastic; middle(?) to late Miocene		
Tmc greenish and reddish gray silty claystone and interbedded light gray sandstone and pebbly sandstone with granitic detritus		
Tmg gray to dark reddish-gray, crudely bedded coarse cobble conglomerate of detritus of gabbro-norite, anorthosite, gneiss and granitic rocks		

SYMBOLS

(not all symbols present on each map)

FORMATION CONTACT	MEMBER CONTACT	CONTACT BETWEEN SURFICIAL SEDIMENTS
dashed where inferred or indefinite; dotted where concealed; dashed with dots where inferred		
FAULT: Dashed where indefinite or inferred, dotted where concealed, queried where existence is doubtful. Parallel arrows indicate inferred relative lateral movement. Relative vertical movement is shown by U/D (U=upthrown side, D=downthrown side). Short arrow indicates dip of fault plane. Sawtooth on upper plate of low angle thrust fault.		
FOLDS: Arrow on axial trace of fold indicates direction of plunging; dotted where concealed by surficial sediments		
ANTICLINE:		
SYNCLINE:		
STRIKE AND DIP OF STRATIFIED ROCKS: Inclined (as appropriate), horizontal, overturned, inclined (approximate), vertical		
DIRECTION OF LANDSLIDE MOVEMENT	SANDSTONE CONGLOMERATE EXPLORATORY OIL OR GAS WELL	ABANDONED EXPLORATORY OIL WELLS (ON TOPOGRAPHIC BASE MAP)

SOURCE: GEOLOGIC MAP OF THE SAN FERNANDO AND VAN NUYS (NORTH 1/2 QUADRANGLES BY THOMAS W. DIBBLEE, JR., 1991, # DF-33)

ALLAN E. SEWARD
ENGINEERING GEOLOGY, INC.
Geological And Geotechnical Consultants

GEOLOGIC MAP BY T.W.DIBBLEE, JR.

Job No.: 20-2653-5 DATE: 10/14/20

6.4 Ground Water

Based on the historically highest ground water contours included in the Seismic Hazard Zone Report for the San Fernando 7.5-Minute Quadrangle (Plate 1.2), the closest historic high groundwater elevation is the 150-ft contour located approximately 3,000 feet to the west in the Pacoima Canyon wash, and over 6,000 feet to the southwest beyond the mouth of Lopez Canyon. However, in the *Ground-Water Conditions* section of the Seismic Hazard Zone report, ground water is considered relatively shallow in all canyon areas of the San Gabriel Mountains. The shallow and relatively less permeable bedrock below the alluvium helps to maintain shallow ground water conditions that fluctuate seasonally and with significant rain events.

Review of Los Angeles County water well data indicates that an inactive well (No. 6009) is located in a tributary to Lopez Canyon, approximately 650 ft to the northwest of the project site. The well record includes data from one reading conducted on 7/8/59 with a measured ground water depth of 25.2 feet.

Ground water was encountered in the alluvium just above the bedrock contact in borings HS-4 at 29 feet and HS-5 at 25 feet. Based on the lack of ground water observed in the underlying bedrock and results of in-situ moisture content testing of bedrock material, this ground water is considered to be a perched condition. Ground water was not encountered in the remainder of the borings performed for this investigation. In the referenced report by Foundation Engineers Co., Inc., ground water was not encountered in their investigation conducted in 1974, which reached depths of up to 18 feet.

Seasonal fluctuations in ground water levels or development of perched water conditions will occur in the alluvium due to precipitation, storm water, irrigation, and other factors not evident at the time of our study. Based on ground water information reviewed, historically high static ground water is estimated to be no shallower than 15 feet beneath existing grade.

Ground water is not anticipated to be encountered during construction or have an adverse impact to design.

6.5 Infiltration Characteristics

6.5.1 Introduction

Infiltration testing was performed in borings PB-1 and PB-2 to evaluate feasibility of low impact development stormwater quality control measures with an infiltration component. Preliminary locations and infiltration invert depths were provided to us by the civil engineer, LDC. Borings PB-1 and PB-2 were drilled in the vicinity of hollow-stem-auger borings HS-4 and HS-5, which were used to assess subsurface conditions at and below a

preliminary infiltration invert depth of 12 feet. Boring PB-2 is located within 10 ft of Boring HS-5. Due to difficult drilling conditions and presumed resistant cobble layer encountered in Boring HS-4 (between 7 and 12 feet in depth) and at the initial location of Boring PB-1 (originally within 10 feet of HS-4), Boring PB-1 was relocated to the current location shown on the Geotechnical Map, which is approximately 40 ft from Boring HS-4. However, the same resistant layer was encountered again in PB-1 near the test invert elevation, presumably resulting in a significantly lower measured infiltration rate.

Field results of the infiltration test as elapsed time (minutes) versus the raw, incremental infiltration rate (inches/minute) are graphically illustrated on the attached Boring Percolation Test Reports, **Figures A1** and **A2**. The measured raw infiltration rates at a stabilized flow rate were 1.10 inches/hour at PB-1 and 7.35 inches/hour at PB-2. The infiltration surface area used to calculate the infiltration rate is equal to the sum of the wetted bottom surface area and wetted sidewall surface area for the 2-ft water height maintained in the borehole during the test period.

6.5.2 Reduction Factors

In accordance with County of Los Angeles GMED infiltration design requirements, the measured infiltration rate should be corrected using the reduction factors defined below in **Table 1** to determine a design value that will represent the long-term performance of the storm water infiltration device.

Table 1 – Reduction Factors

REDUCTION FACTOR	DEFINITION	VALUE
RF_T	Test-specific reduction factor to account for direction of flow during the test and reliability of the test.	2
RF_V	Site variability, number of tests, and thoroughness of subsurface investigation	1 to 3
RF_S	Long-term siltation, plugging, and maintenance	1 to 3
Total reduction factor, $RF = RF_T + RF_V + RF_S$		
Design infiltration rate = measured infiltration rate / RF		

The stabilized infiltration rates measured in the field using the Boring Percolation test procedure should be adjusted using a reduction factor $RF_T = 2$, as indicated in the GMED LID Guidelines. A reduction of the measured infiltration rate due to number of tests and thoroughness of investigation is not considered applicable at this time and an infiltration reduction factor of $RF_V = 1$ has been assumed for best-case scenario. It is assumed that the storm water will be pre-treated prior to infiltration and that the infiltration devices will be subject to an operation and maintenance plan for ongoing maintenance provisions. However, long-term performance due to siltation has been shown to reduce infiltration

rates even with maintenance. Therefore, a reduction factor of $RF_s = 1.5$ is assumed.

6.5.3 Results and Discussion

A summary of the measured infiltration rates, applied reduction factors, and associated corrected infiltration rates are provided in **Table 2**.

Table 2 – Summary of Infiltration Test Results

GEOLOGIC UNIT	TEST LOCATION	FINER THAN NO. 200 SIEVE SIZE, % ¹	MEASURED INFILTRATION RATE, INCHES/HOUR	REDUCTION FACTORS			CORRECTED INFILTRATION RATE, INCHES/HOUR
				RF_T	RF_V	RF_s	
Qal	PB-1	11.5	1.10	2	1	1.5	0.24
	PB-2	7.3	7.35	2	1	1.5	1.63

Results of on-site field testing and applied reduction factors yield corrected infiltration rates of 0.24 and 1.63 in/hr. The substantially lower infiltration rate measured in PB-1 is likely due to a resistant cobble layer at that test elevation. Based on the coarse-grained nature of the alluvium and limited thickness and lateral extent of resistant cobble layers encountered during subsurface exploration, site soils are generally conducive to stormwater infiltration. The infiltration rate obtained in boring PB-2 is considered representative and may be used for preliminary design purposes. Siting of LID stormwater quality control measures with an infiltration component shall be reviewed by this office relative to potentially resistant cobble layers that may inhibit infiltration.

6.6 Soil Shear Strength

Direct Shear testing was performed on California drive ring samples of Quaternary alluvial soils and on soil samples remolded from a blend of on-site soils collected within the upper 10 feet at the project site. Results of the testing are presented in **Appendix B** and were used to select the following design shear strength parameters for site materials.

Table 3 – Summary of Shear Strength Parameters

MATERIAL	MOIST UNIT WEIGHT, PCF	PEAK SHEAR STRENGTH		RESIDUAL SHEAR STRENGTH	
		PHI, DEGREES	COHESION, PSF	PHI, DEGREES	COHESION, PSF
Alluvium (Qal)	130	35	100	28	100
Proposed Compacted Fill (Cf)	130	34	260	32	60

¹ Finer than No 200 sieve size measured in adjacent hollow-stem auger borings HS-4 and HS-5.

6.7 Soil Compressibility

SPT blow count data, in-situ dry density and moisture content, and results of hydro-compression tests performed on soil samples from the borings were used to evaluate compressibility of alluvial soils under static loading conditions from new foundations. Based on this evaluation, potentially compressible layers were identified in the upper 10 feet. The recommended removal depths provided in the Earthworks Recommendations section of this report consider these data.

In general, soils that have an in-situ dry density of 108 pcf or less and in-situ moisture content of 8 percent or less are considered susceptible to hydro-compression. Results of in-situ dry density testing and sampler blow count data indicates that on-site alluvial soils do not fit these criteria. However, two samples with the lowest measured dry density that have in-situ moisture contents less than 8 percent were selected for testing (HS-1 at 9 ft and HS-5 at 12 ft). Test results of the samples of the alluvium show less than 1% settlement due to hydro-compression (see **Appendix B** for lab test data). No significant hydro-compression effects due to water incursion are expected at the site after the removals recommended in the Earthwork and Grading section of this report are performed.

6.8 Expansion Potential of Soils

Based on our visual observation of samples and during drilling operations, in-situ soils at the site have a very low to low expansion potential. It is anticipated that site soils when removed, mixed, and replaced as a compacted fill will have a **very low** expansion potential (per ASTM D4829 expansion potential classification).

The Expansion Index of building pad soils should be measured or visually assessed at the completion of grading in order to confirm the foundations recommendations.

6.9 Soil Corrosivity

The Geotechnical and Materials Engineering Division (GMED) of the Los Angeles County Department of Public Works regards soil at a site to be corrosive to concrete and/or steel if the measured resistivity is 1,000 ohm-cm or less, and/or if the sulfate concentration is 2,000 ppm (0.20%) or greater, and/or if the pH is 5.5 or less. Also, a soil with a chloride concentration greater than or equal to 500 ppm is considered deleterious to ferrous metals.

Soil resistivity, chloride content, soluble sulfate content, and pH were measured on a mixture of alluvial soils collected from Borings HS-2 and HS-4 at a depth of 0 to 10 feet to assess the potential corrosive effects on concrete and metals. Results of this testing are presented in Table B1 (**Appendix B**) and are discussed below.

- The measured resistivity value of the soil sample was 9,518 ohm-cm (which classifies

as moderately corrosive to ferrous metals, per Los Angeles County Department of Public Works classification).

- Chloride content of the soil sample was 186 parts per million (ppm). Soils in this chloride content range have a negligible effect on concrete or ferrous metals.
- Sulfate content of the soil sample was 0.02 percent. Soils in this sulfate content range have a negligible effect on concrete per ACI 318 (Table 4.3.1).
- Based on the pH value measured in the soil sample (7.81), acidity of site soils is low and not anticipated to increase soil corrosivity.

7.0 SEISMIC CONSIDERATIONS

7.1 Introduction

The subject property is within the Transverse Ranges Geomorphic Province of southern California. The Transverse Ranges consist of a series of west-trending mountains and intervening valleys. These ranges largely resulted from north-south compression, ultimately causing east-west-trending folds and thrust faults. The San Fernando section of the Sierra Madre Fault Zone is located within 0.5 miles of the site. Other faults in the vicinity of the site include the Northridge blind thrust fault, Verdugo reverse fault, and San Gabriel right-lateral strike-slip fault.

The southern California region is traversed by the San Andreas fault, which is a transform boundary between the Pacific Plate and the North American Plate. The San Andreas fault is part of a system of northwest-striking, right-lateral faults that are generally historically active, as evidenced by the June 28, 1992 Landers (M7.3) earthquake. The San Andreas fault is located approximately 22 miles to the north-northeast.

The southern California region is seismically active and commonly experiences strong ground shaking resulting from earthquakes along active faults. Earthquakes along these faults are part of a continuous, naturally occurring process, which has contributed to the characteristic landscape of the region. Common geologic hazards associated with earthquakes are discussed below and include **Ground Rupture**, **Ground Motion**, and **Ground Failure**.

7.2 Ground Rupture

Earthquake faults in southern California that are defined as active may present a hazard of fault rupture. The California Department of Conservation, California Geologic Survey (CGS), Special Publication 42 defines an active fault as one which has had surface displacement within Holocene time (about the last 11,000 years).

The potential for ground rupture on the site was evaluated utilizing published maps and references. Review of the Earthquake Zones of Required Investigation map for the San Fernando Quadrangle, provided digitally on the CGS EQZ web application, indicate that there are not any known active faults (i.e. Earthquake Fault Zones) within the project site, per Alquist-Priolo criteria (see **Figure C1**). However, the nearest Earthquake Fault Zone is delineated for the Sierra Madre Fault Zone located approximately 1500 feet south of the project site. Movement along a segment of this fault zone produced the 6.7M 1971 San Fernando earthquake, which resulted in apparent offsets along a complex set of discontinuous thrust faults. The active **San Andreas fault** is located about 23.1 miles northeast of the project site.

Numerous blind (buried) thrust faults are present in the San Fernando Valley. The January 17, 1994 Northridge (M6.8) Earthquake occurred on a south-dipping blind thrust fault which uplifted the Santa Susana Mountains at least 40 cm. These faults were not exposed at the ground surface and are not considered to be a potential fault-related ground rupture hazard to the project site.

Based on our research, the possibility of fault-related ground rupture at the site is considered to be low over the design life of the proposed development.

7.3 Ground Motion

7.3.1 General

The project site is located in southern California, which is in a geologically and seismically active region where large magnitude, potentially destructive earthquakes are common. Therefore, it is reasonable to assume that moderate or large magnitude earthquakes along any of the numerous faults in the region are expected to produce strong ground shaking at the project site in the future.

The current standards for construction provided in the 2019 California Building Code are designed to safeguard against major failures and loss of life, but are not intended to limit damage, maintain functions or provide for easy repair. Per Structural Engineers Association of California (SEAOC), conformance to these recommendations does not constitute any kind of guarantee or assurance that significant structural damage will not occur in the event of a maximum level of earthquake ground motion. However, it is reasonable to expect that a well-planned and constructed structure will not collapse in a major earthquake and that protection of life is reasonably provided, but not with complete assurance.

Although research on earthquakes during the last fifty years has greatly enhanced the level

of understanding of earthquake faulting in California, the record is much too short to constrain behavior of all faults in southern California and the attenuation characteristics of all areas relative to each future potential earthquake. Predicted accelerations should, therefore, be considered **rough estimates** rather than precise facts and ground motions from future earthquakes may exceed the predicted accelerations. Neither the **Time, Location, nor Magnitude** of an earthquake can be accurately predicted at this time.

7.3.2 Earthquake Magnitude

Earthquake **magnitude** is a quantitative measure of the strength of an earthquake or the strain energy released by it, as determined by seismographic or geologic observations. It does not vary with distance or the underlying earth material. This differs from **intensity**, which is a qualitative measure of the effects a given earthquake has on people, structures, loose objects, and the ground at a specific location. Intensity generally increases with increasing magnitude and in areas underlain by unconsolidated materials and decreases with distance from the epicenter. Approximate locations of historic earthquakes are shown on the appended Fault and Earthquake Epicenter Location Map (**Figure C2**).

The table below presents the distances to nearby significant faults located within about 20 miles of the project site. The site-to-source distances were obtained from the USGS fault parameters online database (based on 2008 National Seismic Hazards Map). The maximum earthquake magnitudes (M) were calculated using the Ellsworth-B magnitude-area scaling relationship presented in Appendix E of the Uniform California Earthquake Rupture Forecast, Version 3 (UCERF3).

Table 4 – Summary of Major Known Faults Within 20 Miles

DISTANCE (MILES)	FAULT NAME	DIP DIRECTION	SLIP SENSE	MAGNITUDE
0.7	Sierra Madre (San Fernando)	N	thrust	6.7
0.7	Sierra Madre Connected		reverse	7.3
0.9	Northridge	S	thrust	6.9
3.2	Verdugo	NE	reverse	6.9
3.7	San Gabriel	N	strike slip	7.3
5.9	Santa Susana, alt 1	N	reverse	6.9
6.4	Sierra Madre	N	reverse	7.2
11.8	Holser, alt 1	S	reverse	6.9
14.0	Hollywood	N	strike slip	6.7
14.3	Elysian Park (Upper)	NE	reverse	6.7
14.8	Santa Monica Connected alt 2		strike slip	7.3
15.9	Raymond	N	strike slip	6.8

DISTANCE (MILES)	FAULT NAME	DIP DIRECTION	SLIP SENSE	MAGNITUDE
17.2	Simi-Santa Rosa		strike slip	6.9
17.9	Newport Inglewood Connected alt 1		strike slip	7.6
18.9	Puente Hills (LA)	N	thrust	7.0
19.8	Oak Ridge Connected		reverse	7.4

7.3.3 Peak Ground Acceleration

The peak ground acceleration consistent with maximum considered earthquake geometric mean (MCE_G) ground motions was evaluated at the site for stiff soil conditions (Site Class D). The mapped MCE_G peak ground acceleration (ASCE 7-16, Figure 22-9) adjusted for Site Class effects (PGAM) was determined using the OSHPD Seismic Design Maps web tool by the Structural Engineers Association of California (SEAOC). Based on this evaluation, a PGAM of 1.10g would be produced by MCE_G ground motions. This mapped value incorporates a 2% probability of exceedance in 50 years (i.e. 2,475-year return period).

Site-specific ground motion procedures were also used to evaluate the MCE_G peak ground acceleration, PGAM, in accordance with ASCE 7-16 Section 21.5. A probabilistic geometric mean PGA of 1.13g was determined using the uniform hazard ground motion (UHGM) with a 2% probability of exceedance in 50 years. The UHGM was calculated using the *USGS Risk-Targeted Ground Motion Calculator*. A deterministic geometric mean PGA of 1.04g was calculated as the largest 84th-percentile PGA for the characteristic earthquake. Based on UCERF3 fault data and a weighted average of the 2014 NGA West-2 ground motion prediction equations (GMPEs), the characteristic earthquake that will produce the largest 84th-percentile PGA at the site will occur on the San Fernando section of the Sierra Madre fault zone. The site-specific PGAM was taken as the lesser of the probabilistic and deterministic geometric mean peak ground accelerations, but no less than 80 percent of the mapped PGAM.

Based on our evaluation, the MCE_G peak ground acceleration (PGAM) used for geotechnical applications is 1.04g.

7.3.4 Deaggregation of Fault Hazard

A probabilistic analysis evaluates a range of magnitudes from 5.0 to the maximum magnitude for each fault. However, the dominant magnitude which statistically generates the peak acceleration within a limited time period (e.g. 2,475 years) is typically less than the maximum magnitude for a given fault. In order to evaluate what dominant magnitude-distance combination produces the site PGA, the hazard was deaggregated using the

USGS *Beta – Unified Hazard Tool* and an estimated average shear wave velocity ($V_{s,30}$) for the upper 100 feet (~30 meters) of 360 meters per second based on Site Class C/D boundary conditions. Review of the magnitude-distance contributions to the hazard (**Table C1**) indicates that the site PGA would most likely be generated by a magnitude 6.3 earthquake within 4 km of the project site, as shown graphically in **Figure C3**. The dominant fault controlling maximum potential ground accelerations is the San Fernando section of the Sierra Madre fault zone, with secondary impacts from the Santa Susana fault.

The peak ground acceleration used for evaluation of liquefaction potential and associated phenomena was corrected to account for an earthquake duration typical of an “average” magnitude 7.5 event. This was accomplished by applying a magnitude scaling factor based on the empirical relationship by Youd and Idriss (1997). Based on a magnitude 6.3 earthquake, a corrected peak ground acceleration of 0.66g was used in our liquefaction analyses (see **Appendix D**).

7.4 Ground Failure

Ground Failure is a general term describing seismically induced secondary permanent ground deformation caused by strong ground motion. This includes liquefaction, lateral spreading, seismic settlement of poorly consolidated materials (dynamic densification), differential materials response, slope failures, sympathetic movement on weak bedding planes or non-causative faults, shattered ridge effects and ground lurching. Review of the Earthquake Zones of Required Investigation map for the San Fernando Quadrangle indicates that the subject site is located within an area of required investigation for liquefaction (see **Figure C1**).

Potential secondary seismic hazards to the building are described below. The potential for liquefaction and seismic settlement are evaluated in detail in **Appendix D**. The potential for adverse impacts to the proposed development from liquefaction and other secondary seismic effects is considered to be low to non-existent provided that our recommendations are incorporated into the future grading plan and implemented during construction.

7.4.1 Potential for Liquefaction and Associated Ground Failure

Liquefaction is a phenomenon in which pore water pressure generated by earthquake shaking causes sudden, temporary reduction or loss of shear strength in saturated soils with negligible to low plasticity. Structures founded on liquefied soils may experience subsidence and/or lateral movement. Potential for seismic soil liquefaction and the magnitude of associated liquefaction-induced ground failure (i.e. seismic settlement, lateral spread displacements, and surface manifestation) were evaluated using data from

hollow-stem auger Boring HS-4. The calculation procedures described in the following references were used herein for our assessment:

- *Cyclic Liquefaction and its Evaluation Based on the SPT and CPT*, by Robertson and Wride, 1997.
- *Liquefaction Resistance of Soils: Summary Report* (NCEER/NSF, 2001), by Youd, Idriss, et al.
- *SPT-Based Probabilistic Assessment of Seismic Soil Liquefaction Potential*, by Cetin, et. al., 2004.
- *Revised Multilinear Regression Equations for Prediction of Lateral Spread Displacement*, Youd, Hanson, Corbett, and Bartlett, ASCE Journal of Geotechnical and Geoenvironmental Engineering, December 2002.
- *Evaluation of Settlements in Sands Due to Earthquake Shaking*, Tokimatsu and Seed, ASCE, August, 1987.

Additionally, our assessment of liquefaction potential and associated phenomena at the site was performed in accordance with the following guidelines:

- *Review of Geotechnical Reports Addressing Liquefaction*, memorandum from Los Angeles County Department of Public Works (LACDPW), dated February 24, 2009.
- *Special Publication 117A: Guidelines for Evaluating and Mitigating Seismic Hazards in California*, revised and re-adopted by California State Mining and Geology Board, September 11, 2008.
- *Manual for Preparation of Geotechnical Reports*, LACDPW, July 2013.

Factors that affect potential for liquefaction triggering at the site include estimated ground motion parameters, engineering characteristics of site soils, historic high ground water depth, and proposed grading (i.e., removals and/or raising of grade). Based on our site-specific ground motion hazard analysis, the maximum considered earthquake geometric mean (MCE_G) peak ground acceleration ($PGAM$) generated by a magnitude 6.3 earthquake is 1.04g. This magnitude-acceleration pair is considered to be equivalent to a magnitude 7.5 earthquake (i.e., the “standard” magnitude used to evaluate liquefaction triggering) and a corresponding PGA of 0.66g. This magnitude-acceleration pair was used in our liquefaction potential analyses. Boring $N_{1,60}$ values from SPT blow count data, soil classifications, and measured fines content were used to characterize site soils at each sample depth at Boring HS-4. As discussed in the Ground Water section of the report, the historic high ground water depth at the site is estimated to be greater than 15 feet beneath existing grade. The liquefaction potential analyses performed include the recommended removal and re-compaction of site soils.

Results of our liquefaction assessment for the analyzed boring location at the site is graphically summarized herein on **Figure D1**, SPT-Based Assessment of Seismic Soil Liquefaction Potential. This sheet present plots of depth vs. normalized SPT blow count corrected for fines content $(N_1)_{60,cs}$, laboratory fines content, FC, cyclic shear stress induced by earthquake shaking, resistance to liquefaction caused by cyclic shear stress, and cumulative settlement that would be caused by earthquake shaking (before and after recommended removals). The sheets also display ground water depths at the time of the drilling and estimated historic high ground water depth.

Based on the results, the potential for liquefaction in soil layers beneath the proposed structure is low, and that no significant seismically-induced ground surface settlement is anticipated. Potential for lateral spreading is believed to be negligible since laterally continuous, potentially liquefiable soil layers with a relative density corresponding to $N_{160} \leq 15$ are not present at the site.

Calculations for Standard Penetration Test Corrections, Liquefaction Triggering and Seismically-Induced Settlement are included in **Appendix D**.

7.4.2 Potential for Other Modes of Ground Failure

Earthquake-induced slope failures include activation and reactivation of landslides, rock falls, debris flows and surficial failures. Based on location of the proposed building within the canyon, the potential for earthquake-induced slope failures to adversely impact the proposed development is considered negligible.

8.0 GENERAL CONCLUSIONS AND GRADING RECOMMENDATIONS

8.1 Earthwork and Grading Recommendations

All grading and earthworks shall be observed and tested by the Project Geotechnical Engineer, Engineering Geologist, and/or their authorized representatives. These tasks should be performed in accordance with the recommendations contained in this report, in accordance with the current Building Code requirements of the County of Los Angeles, and in accordance with this firm's Recommended Earthwork Specifications (See **Appendix E**).

8.1.1 Site Preparation

The purpose of site preparation is to clear the site of organics (vegetation), topsoil, and unsuitable materials, and to grade the site to provide a firm base for compacted fill, as applicable. All vegetation, topsoil, debris, existing disturbed fills, undocumented artificial fill, and unsuitable alluvial soils should be removed from ground surfaces on which compacted fill will be placed.

8.1.2 Removals

To mitigate potential compressibility of near-surface soils and to provide a uniform bearing surface for at-grade and subterranean foundation elements, remedial removals are recommended. The depth and lateral limits of removals are shown on the attached Geotechnical Map (**Plate I**) and Cross Sections (**Plate II**) and are discussed below:

- The existing alluvial soils and artificial fill beneath the proposed building should be completely removed to a depth of 10 feet beneath existing soil subgrade and replaced as a compacted fill. At subterranean locations, or where proposed grade is lower than existing grade, the removals should extend at least 3 feet beneath bottom of proposed footings. Recommended removals for the building should extend laterally beyond proposed adjacent retaining walls.
- The recommended removal bottoms should extend outside the foundation footprint at a 1:1 or flatter projection from the bottom of the foundation element down to the recommended removal depth. If the tract boundary along the east side of the building is a constraint to achieve structural removals, temporary shoring or slot-cutting may be required.
- Transitions between deeper and shallower removals (i.e. at edges of subterranean footprint) should be slope at a 2:1 (h:v) gradient, or shallower.
- The recommended removals are intended to limit total settlement of foundations subjected to anticipated loads (dead plus live) to 1.0 inch, or less. If design (dead plus live) loads warrant the revision of foundation dimensions or induce stresses to the subgrade that exceed the allowable bearing capacity, the recommended removal depths must be re-evaluated.
- In areas of proposed driveways and parking, existing soils should be removed and replaced with compacted fill to a depth of at least 12 inches below pavement subgrade or existing grade, whichever is deeper, to provide a uniform base for the pavement.

Removal areas shall be observed by the Geotechnical Engineer, or his authorized representative, prior to placement of compacted fill, to verify the removal of all unsuitable materials. Soft soils identified during field observations should be evaluated and may warrant additional removals. The exact depth and extent of necessary removals will be decided in the field during the grading operations, when observations and more location-specific evaluations can be performed.

8.1.3 Preparation of Removal Bottoms

After the ground surface to receive fill has been exposed, it shall be ripped to a minimum depth of six inches, aerated or moistened to Optimum Moisture Content or above, and thoroughly mixed to obtain a nearly uniform moisture condition and uniform blend of materials, and then compacted to at least 95 percent of Maximum Dry Density, per ASTM D1557.

8.1.4 Fill Materials

Based on material types encountered during our investigation, on-site soils within the range of depths of proposed removal and re-compaction, except debris and organic matter, classify predominantly as poorly graded sands with gravels with interbeds of silty sand and clayey sand. When thoroughly mixed and placed as a compacted fill these soils are considered suitable for support of the proposed building. Rocks or hard fragments larger than four (4) inches in dimension should not compose more than 25 percent of a fill and/or fill lift. Irreducible rock or similar material larger than eight (8) inches in dimension should not be placed in the fill without approval of the Geotechnical Engineer.

8.1.5 Placement and Compaction of Fill Materials

All fill materials should be placed in lifts not exceeding 8 inches prior to compaction, then aerated or water-conditioned to Optimum Moisture Content (OMC), or above, then thoroughly mixed to produce a nearly uniform moisture content and uniform blend of materials, and then compacted to at least 95 percent of Maximum Dry Density, in accordance with ASTM D1557.

8.1.6 Shrinkage and Bulking

Based on measured in-situ density values within the range of the recommended removal depths and assuming that fill will be compacted to an average of about of 96 percent of maximum dry density (per ASTM D1557), it is anticipated that soil shrinkage (i.e., the reduction in initial soil volume caused by compaction of excavated soil divided by the initial soil volume prior to excavation) will be small. However, actual shrinkage (or bulking) quantities will depend on the degree of compaction achieved during earthwork operations. The supervising civil engineer should design pad grades with sufficient flexibility to accommodate a possible shrinkage or bulking of fill of up to 5 percent of the total grading volume.

8.1.7 Oversize Material

Oversized, irreducible rocks are likely present in the alluvium within the Lopez Canyon drainage. Cobbly layers may be encountered within the structural removals or over-

excavation of pavement areas. Oversized material generated as a result of cut and removals will require special handling and off-site disposal.

8.1.8 Rippability

The project site is underlain by undocumented artificial fill and alluvial deposits that can be ripped using conventional grading equipment.

8.1.9 Import Fill

All imported fill shall be observed, tested and approved by this firm prior to use at the project site. Import soils to be used in the building pad areas should have an expansion index of less than 20 and corrosive characteristics that are equally or less detrimental than that of the existing onsite soils.

8.2 Natural Slopes

There are ascending 2:1 (h:v) gradient or flatter natural slopes to the east and west of the proposed building. The toe of the east-facing natural slope is 65 to 80 feet to the west of the proposed building. The toe of the west-facing natural slope is at least 100 feet to the east of the proposed building. The bedrock bedding dips are neutral to the ascending natural slopes, which are considered geologically grossly stable.

8.3 Low Impact Development

Though not shown on the plan, the Civil Engineer has indicated potential low impact development (LID) stormwater quality control measures within new vehicle pavement areas proposed to the south of the building. Based on preliminary infiltration testing at the project site, LID stormwater quality control measures with an infiltration component are considered feasible. A corrected infiltration rate of 1.6 inches/hour may be used for preliminary design and siting. The type and siting of LID devices should be reviewed by this office to assess compatibility with the recommendations in this report and to verify conformance to GMED LID Guidelines.

8.4 Oil Wells and Water Wells

No oil wells were observed on the site. In addition, review of the Munger Map Book and California Division of Oil and Gas records (DOGGR website) indicates that no oil wells have been drilled on or immediately adjacent to the site. The closest mapped oil well (dry hole) was located approximately 3,200 feet down canyon (API #0403706063) and currently has a plugged status.

Review of Los Angeles County Flood Control District (LACFCD) website indicates that no water wells are located on the project site. The closest active water well, Well Number

1459D, is located approximately 5,850 ft to the east-southeast.

If an oil well or water well is encountered during future grading/construction operations at the site, the location should be surveyed and the well conditions evaluated immediately.

8.5 Sewage Disposal

It is our understanding that sewage disposal will be by an on-site wastewater treatment system (OWTS). Details regarding OWTS improvements or modifications to the existing on-site wastewater treatment plant have not been made available.

8.6 Drainage

Roof drainage should be collected in gutters and downspouts and discharged at approved locations away from the proposed structure.

Water should not be allowed to stand or pond on structural pads, parking areas, level graded areas, or constructed slopes. Water that flows onto these areas should be conducted to appropriate discharge locations via non-erodible drainage devices. Drainage devices should be inspected periodically and should be kept clear of debris. Drainage and erosion control should be designed in accordance with the standards set forth in the 2020 County of Los Angeles Building Code.

Any modification of the grade of building pad, parking areas, etc. after certification by the project Civil Engineer could adversely affect drainage at the site. Future landscaping, construction of walkways, planters and walls, etc. must never modify site drainage unless additional measures to enhance drainage (such as area drains, additional grading, etc.) are designed and constructed in compliance with applicable County of Los Angeles regulations.

8.7 Landscaping

All final grades should be sloped away from the building foundations to allow rapid removal of surface water runoff. No ponding of water should be allowed adjacent to the foundations. Plants and other landscaped vegetation requiring excessive watering should be avoided adjacent to the building foundations. Should landscaping be constructed, an effective water-tight barrier should be provided to prevent water from affecting the building foundations.

8.8 Planters

Planters located adjacent to proposed building should either be sealed or provided with drains that discharge irrigation water well away from footing foundations of the proposed buildings.

9.0 FOUNDATION RECOMMENDATIONS

Conventional shallow column footings and continuous footings are considered adequate for the support of the proposed structure at the site provided the footings are supported entirely on competent compacted fill soils. Footing design should be in accordance with the minimum foundation requirements of the 2020 County of Los Angeles Building Code.

Once the design and foundation loading configuration proceeds to a more finalized plan, the recommendations within this report should be reviewed and revised, if necessary. If the proposed building loads will exceed those estimated herein, the potential for settlement should be reevaluated. Additionally, observations made during earthworks for this project may warrant revisions to the recommendations herein.

9.1 Conventional Shallow Footing Foundations

9.1.1 Assumptions

- The **expansion potential** of foundation subgrades is **very low**.
- Minimum continuous footing width: 15 inches (2-story) and 18 inches (3-story and 4-story).
- Minimum column footing width: 24 inches.
- Minimum embedment of footing foundations beneath lowest adjacent soil subgrade elevation: 36 inches.
- Bearing foundation material: Certified compacted fill (Cef).
- Footings are not influenced by other footing loads.
- Removals beneath the proposed grade: per the Removals section of this report.

9.1.2 Vertical Bearing Capacity Parameters

- Maximum allowable static plus sustained live load bearing pressure for footing foundations (with minimum required embedment and width): 3,000 psf.
- Increase in allowable bearing pressure: 300 psf for each additional foot of embedment or footing width, up to a maximum of 4,500 psf. Additional grading removals may be required for foundation elements deeper than 36 inches.
- Increase to allowable (static plus sustained live load) bearing pressure when considering short-term seismic loads or wind loads: One-third.

9.1.3 Settlement

Total settlement due to static loading of footing foundations designed as recommended

above is estimated to be about 1.5 inch or less, and differential settlement of footing foundations over a horizontal distance of 30 feet may be assumed to be about 1 inch, or less. Foundation settlement caused by earthquake shaking is expected to be negligible.

9.1.4 Resistance to Lateral Loads

- Lateral passive pressure that can be developed against the side of footing foundations is 250 psf per foot of depth beneath lowest adjacent soil subgrade, to a maximum of 2,500 psf. If care is not taken to compact soil adjacent to footing foundations or if the soil surface adjacent to footing foundations is not protected against erosion, the passive resistance of soil provided by the upper one foot of foundation embedment should be neglected.
- A one-third increase in allowable passive pressure may be used for short-term seismic and wind loads.
- The allowable frictional resistance that can be developed beneath the base of footing foundations may be calculated by multiplying the dead load by a friction coefficient of 0.38.
- The passive pressure and frictional resistance may be used concurrently without reduction.

9.1.5 Auxiliary Structures

Small auxiliary structures, such as block walls up to 6 feet high, planter walls or trash enclosures, which will not be tied-in to the proposed structures, may be supported on conventional footing foundations bearing on a minimum of 12 inches of engineered fill. The foundations may be designed for a bearing pressure of 1,500 psf and should be a minimum of 12 inches in width and 18 inches in depth below the lowest adjacent grade.

9.1.6 Additional Foundation Recommendations

Additional recommendations for shallow foundations that should be incorporated into the design and construction of future structures, as applicable, are presented below.

- All continuous footing foundations shall be reinforced with at least four #4 steel bars (two placed near the top, and two placed near the bottom of the foundations) or by the requirements of the applicable structural design code for the design loadings, whichever is greater.
- Isolated footings that support exterior structural columns shall be structurally connected to the main foundation system in at least two orthogonal horizontal directions.

- The sides of footings that support interior columns should be connected to the closest adjacent (isolated spread footing and/or continuous footing) foundations using reinforced concrete tie beams. The tie beams should be at least 12 inches wide and should be embedded at least 12 inches beneath pad grade. Reinforcement of the tie beams should be at least ρ_{\min} ($200/f_y$).
- The footing excavations should be pre-moistened to above optimum moisture content and free of all loose or sloughed material prior to placement of concrete. The footing area should not be allowed to desiccate prior to placing concrete.
- Foundation excavations should be observed by a representative of this firm prior to placement of forms, reinforcement, or concrete, to verify that the excavations are embedded into the recommended material and prepared as specified herein.

9.2 Concrete Slabs-On-Grade

9.2.1 General

Concrete slab-on-grade floors shall be supported on a fill subgrade compacted to 95 percent of Maximum Dry Density (per ASTM D1557). The design of the required slab thickness and reinforcement is under the purview of the structural engineer. The following are minimum recommendations for design of conventional slab-on-grade floors based on a medium expansion potential of the fill subgrade beneath the floor slabs.

- Slab-on-grade thickness: at least 4 inches.
- Slab reinforcement: #3 Rebar at 18" each way.
- Concrete used in floor slabs should satisfy the requirements presented in Chapter 19 of the California Building Code.

In order to minimize shrinkage cracking of concrete slab-on-grade, the slabs should be constructed using low-slump concrete and with crack control joints in both horizontal directions. In any case, concrete used in slabs-on-grade should satisfy the requirements of Chapter 19 of the California Building Code.

In order to reduce moisture intrusion from utility trenches beneath slabs on grade, utility trenches should be plugged with lean concrete or concrete slurry at foundation perimeters. The plug should extend under the full width of the footing foundation and should extend at least 24 inches along the utility trench in the direction of the slab.

Deflections, shears, and moments in concrete slabs-on-grade caused by applied vertical pressures up to 1000 psf may be estimated using a coefficient of vertical subgrade reaction, k_v . The value k_v is defined as the pressure applied by a concrete slab to the subgrade

divided by the resulting settlement of the subgrade and is a function of the subgrade soil type, soil stiffness, dimensions of the loaded area, base thickness, and base type. A k_v value of 120 psi may be used to represent the soil subgrade at the project site. These values should be adjusted based on the actual dimensions of a loaded area. The coefficient of vertical subgrade reaction for a loaded area of specific width, k_b , may be determined using the following equation, where b equals the width of the loaded area in feet:

$$k_b = k_v [(b + 1) / 2b]$$

9.2.2 Slab Underlayment

Concrete slabs-on-grade may be cast directly on compacted soil subgrade where the migration of moisture up through the slab is not a concern. Where moisture may damage floor coverings such as carpet, hardwood, tile, linoleum, etc., mitigation to help prevent water vapor and capillary rise from penetrating slab-on-grade floors is recommended. Slab underlayment to mitigate vapor transmission is not under the purview of the geotechnical engineer, however, the following specifications based on standard local practice may be incorporated into the design:

- 4 inches of aggregate base should be placed and compacted over the soil subgrade (to act as a capillary break) and overlain with a plastic membrane (10-mil “Visqueen” vapor retarder or approved equivalent) to prevent transmission of water vapor. The plastic membrane should then be overlain by an additional 2-inch thick protective cushion of compacted, well-graded clean sand.
- Alternatively, the omission of the capillary break and placement of an engineered under-slab vapor barrier (e.g. Stego Wrap 15-mil Vapor Barrier) directly between the compacted subgrade surface and concrete slab-on-grade is also acceptable, provided the barrier is installed in accordance with the manufacturer’s instructions.
- The selected membrane should be properly lapped and sealed at all seams and around all plumbing structures and other openings. Care should be taken to prevent sharp objects in the subgrade and/or structures from puncturing the membrane.

Suitability of proposed sand cushion materials should be evaluated in our laboratory prior to transporting them to the subject site.

9.3 Expansive Soils Considerations

Recommendations are provided in this report based on the potential expansion of fill soils, including recommendations for footing embedment and reinforcement. These recommendations depend on the expansion potential that characterizes the foundation soils. The expansion potential of in-situ soils when removed, mixed, and replaced as compacted

fill may be assumed for preliminary design purposes to be **very low** (per ASTM D4829 expansion potential classification).

Geotechnical observation of the soils exposed in the foundation excavations should be performed and the Expansion Index measured (if warranted) in order to verify the applicability of minimum parameters presented herein for design and construction of footing foundations.

9.4 Soil Corrosivity Considerations

Based on the results of sulfate content testing, corrosivity of soils at the site to concrete is expected to be negligible. Therefore, Type I or II Portland cement may be used for concrete structures that will be in contact with site soils. Based on the results of resistivity testing site soils classify as moderately corrosive to metals.

The on-site soils when excavated, mixed and placed as a compacted fill are not anticipated to exhibit corrosive characteristics to concrete or ferrous metals. However, the following precautionary measures may be implemented to mitigate for corrosion potential:

- Steel and wire reinforcement in concrete structures cast against site soils should have at least 3 inches of concrete cover.
- Buried utilities made of ferrous metals should be protected with polyethylene extruded coating, or with tape over primer per AWWA Standard C209 or C203, or with hot-applied coal tar enamel, or as recommended by manufacturers of the utility conduits.
- Metallic pipes that penetrate concrete structures should be surrounded by plastic sleeves, rubber seals, boots, or other dielectric material in order to prevent contact between the pipe and the concrete structure.
- Below-grade ferrous metals should be electrically insulated (isolated) from above-grade metals.

Additional corrosivity testing of soils from the subgrades of footings and floor slabs should be performed following site grading. A corrosion specialist may provide final recommendations for mitigation of potential corrosion of metals and concrete.

10.0 RETAINING WALLS

The following recommendations may be used for design and construction of retaining walls retaining up to 12 feet of backfill that are shown on the current site plan.

10.1 Assumptions

Retaining walls should be founded on clean, non-deleterious, competent compacted fill. The

earth materials exposed at the bottom of the proposed retaining wall footing should be observed by the Soils Engineer/Engineering Geologist or his representative. Recommendations for remedial removals beneath retaining wall footings are presented in the Removals section of this report. If the earth materials in the bottom of the foundation excavation appear to be disturbed, they should be removed and replaced with compacted fill.

10.2 Footing Parameters

Footings that will support conventional retaining walls shall be designed as recommended above for conventional shallow footing foundations for the building, except where superseded below.

10.2.1 Vertical Bearing Capacity

- Minimum footing depth: 24 inches below lowest adjacent soil subgrade.
- Minimum footing width: 24 inches.
- Maximum allowable static plus sustained live load bearing pressure for footing foundations (with minimum required embedment and width): 2,500 psf.
- Allowable increase in bearing pressure for footing embedment deeper than minimum required embedment: 200 psf per additional foot, up to 3,500 psf max.

10.2.2 Resistance to Lateral Loading

- Lateral passive pressure that can be developed against the side of footing foundations is 250 psf per foot of depth beneath lowest adjacent soil subgrade. Passive resistance should be reduced to 125 psf per foot of depth for footings adjacent to sloping ground.
- If care is not taken to compact soil adjacent to footing foundations or if the soil surface adjacent to footing foundations is not protected against erosion, the passive resistance of soil provided by the upper one foot of foundation embedment should be neglected.

10.3 Lateral Earth Pressures

Retaining walls (including building subterranean walls) should be designed to resist lateral (static) earth pressures equal to those exerted by an equivalent fluid with a density not less than the following for active (free-standing) and at-rest (restrained) conditions. A wall is considered restrained if it is prevented from movement greater than $0.002H$ (H = height of wall in feet) at the top of the wall.

Table 5 – Lateral Static Earth Pressure

BACKFILL SLOPE (HORIZONTAL TO VERTICAL)	EQUIVALENT FLUID DENSITY VALUE	
	FREE-STANDING CANTILEVER RETAINING WALLS (ACTIVE CONDITIONS)	RETAINING WALLS RESTRAINED AGAINST ROTATION (AT-REST CONDITIONS)
Level	38 pcf	55 pcf
2:1 max	59 pcf	75 pcf

These equivalent fluid density (EFD) values assume backfill consisting of compacted fill materials with low expansion potential and plasticity, and that drainage will be provided behind walls in order to prevent buildup of water pressure. If soil retained by walls is not drained, the walls should be designed to resist hydro-static water pressures in addition to the applicable active or at-rest soil pressures discussed above.

Additional lateral pressures may be exerted onto building subterranean walls by surcharge loads from adjacent footings that will support at-grade portions of the building. The magnitude of the lateral pressures from footing surcharge loads is dependent on parameters of the footing that is exerting the surcharge, including footing width, applied bearing pressure, and the clear horizontal distance to the subterranean wall. In general, lateral pressures exerted on subterranean walls by adjacent footing loads can be minimized (not eliminated) by maintaining a 1:1 (h:v) projection, or shallower, between the bottom of the wall footing and bottom of the adjacent at-grade footing exerting the surcharge. Footing surcharge conditions should be evaluated on a case-by-case basis upon receipt of the foundation plan.

Additional lateral pressures may be exerted against retaining walls by traffic loads. Potential traffic loads may be represented by a vertical surcharge load of 250 psf. A uniform lateral surcharge pressure against the retaining wall and base can be taken as one-third of this vertical surcharge load.

Walls that will retain more than 6 feet of earth materials shall be designed to resist seismic earth pressures. The total seismic earth pressure (P_{AE}) is equal to the sum of the static lateral earth pressure (P_{static}) and dynamic load increment (ΔP_{AE}). The dynamic load increment can be represented by an equivalent fluid with a density not less than the following:

Table 6 – Dynamic Load Increment

BACKFILL SLOPE (HORIZONTAL TO VERTICAL)	EQUIVALENT FLUID DENSITY VALUE	
	FREE-STANDING CANTILEVER RETAINING WALLS (ACTIVE CONDITIONS)	RETAINING WALLS RESTRAINED AGAINST ROTATION (AT-REST CONDITIONS)
Level	53 pcf	85 pcf
2:1 max	87 pcf	--

Dynamic load increments are calculated as follows in accordance with Administrative Manual S004.0 issued by GMED:

$$\begin{aligned} \text{Restrained wall with level backfill:} & \quad \Delta P_{AE} = 0.5\gamma H^2(0.68 PG_{AM}/g) \\ \text{Unrestrained wall with level backfill:} & \quad \Delta P_{AE} = 0.5\gamma H^2(0.42 PG_{AM}/g) \\ \text{Unrestrained wall with sloping backfill:} & \quad \Delta P_{AE} = 0.5\gamma H^2(0.70 PG_{AM}/g) \end{aligned}$$

where γ is the moist unit weight of retained soil (120 pcf), H is the retained height, and PG_{AM} (1.04g) is the maximum considered earthquake geometric mean (MCE_G) peak ground acceleration.

The equivalent fluid pressures provided for the dynamic load increment are in addition to the equivalent fluid density (EFD) values provided for active and at-rest conditions under static loading. The resultant seismic earth pressure acts at about H/3 from the base of the wall.

10.4 Retaining Wall Drainage

Retaining walls should be provided with a freeboard of at least 6 inches and a standard surface backdrain swale, if applicable (see **Retaining Wall Drainage Detail**). All drainage should flow to the toe of the adjacent slope using non-erodible devices. In order to reduce infiltration of surface water behind retaining walls, the surface backdrain swale should be paved or the surface of the backfill covered with at least 12 inches of low permeability fill for a horizontal distance equal at least to the height of the wall.

A backdrain system should be provided to prevent development of hydrostatic water pressures behind retaining walls. The referenced **Retaining Wall Drainage Detail** and **Alternate Wall Drainage Detail** show drainage recommendations with specifications for drainage materials behind the walls. If a drainage composite is selected for use in lieu of drainage rock it should consist of a high-strength core (compressive strength > 15,000 psi) and a high-flow (flow rate > 140 gpm/ft²) non-woven filter fabric. At locations where moisture migration through walls is undesirable, the side of the wall in contact with backfill soils should be waterproofed. The drainage composite shall be compatible with the waterproofing materials.

10.5 Retaining Wall Backfill

Retaining wall backfill to be certified by this office must be placed in accordance with our recommendations presented in this report and observed and tested by our personnel during placement. Under no circumstances will retaining wall backfill be certified by this office if our recommendations concerning backfill placement are not followed, or if our personnel do not observe the installed backdrain and test the backfill during placement.

To prevent the buildup of lateral soil pressures in excess of the recommended design pressures, over-compaction of fill behind walls should be avoided by placement of wall backfill in lifts not exceeding six inches in thickness and by compacting each lift with hand-operated or self-propelled compaction equipment that weighs less than 1000 pounds. Use of heavier equipment for compacting backfills should be limited to those areas at least 8 feet from retaining walls. If these precautions cannot be maintained, then the respective retaining walls should be either be redesigned to support the significantly higher lateral loads or the walls should be braced to support the higher load during placement and compaction of backfill.

11.0 GROUND MOTION HAZARD ANALYSIS

11.1 General

Based on site soil properties, the site is classified as Site Class D (stiff soils). The mapped risk-targeted MCE_R spectral acceleration parameter at a period of 1 second (S_1) is 0.788. Due to deficiencies in capturing site response for Site Class D soils using the general procedure, site-specific ground motion hazard analysis was performed as required by ASCE 7-16 Section 11.4.8 since S_1 is greater than or equal to 0.2.

11.2 MCE_R Ground Motion Hazard Analysis

Risk-targeted maximum considered earthquake (MCE_R) ground motion hazard analysis was completed using the procedures outlined in ASCE 7-16 Section 21.2.

Probabilistic spectral response accelerations were determined using the uniform hazard ground motion (UHGM) with a 2% probability of exceedance in 50 years and corresponding risk-targeted ground motion (RTGM) with a 1% probability of collapse in 50 years. The UHGM and RTGM were calculated using the *USGS Risk-Targeted Ground Motion Calculator*. Scale factors were applied to the RTGM to yield spectral response accelerations in the direction of maximum horizontal response at each spectral ordinate.

Deterministic spectral response accelerations were taken as the largest 84th-percentile 5% damped spectral response acceleration calculated at each period for characteristic earthquakes in the region. Fault parameters and maximum magnitude of characteristic earthquakes were determined based on fault data and magnitude-area relationships (Ellsworth-B) presented in UCERF3. Using this fault data, spectral response accelerations were calculated (Seyhan, 2015) based on a weighted average of the 2014 NGA West-2 ground motion prediction equations (GMPEs). Scale factors were applied to yield spectral response accelerations in the direction of maximum horizontal response at each spectral ordinate. A deterministic lower limit in conformance with Figure 21.2-1 was applied.

The site-specific MCE_R spectral response acceleration at each period was taken as the lesser of the spectral response accelerations from the probabilistic and deterministic ground motions.

11.3 Design Response Spectrum and Acceleration Parameters

The design response spectrum and design acceleration parameters were calculated in accordance with Sections 21.3 and 21.4, respectively, and are presented on **Figure C4** in Appendix C. The design spectral response accelerations were taken as 2/3 of the site-specific MCE_R spectral response accelerations at each period, but not less than 80% of code-based values from the general procedure utilizing parameter F_a and F_v .

12.0 CONSTRUCTION CONSIDERATIONS

12.1 Excavations, Shoring, and Backfilling of Excavations

Excavations deeper than 3.5 ft should conform to the State Construction Safety Orders of the State Division of Industrial Safety, CAL-OSHA. Temporary excavations in competent artificial fill and alluvial soils up to 3.5 feet in height may be vertical. Temporary excavations shall be no steeper than 1.25:1 (h:v) for slope heights up to 8 feet, and no steeper than 1.5:1 for slope heights up to 12 feet. Excavations deeper than 12 feet are not anticipated but may be evaluated on a case-by-case basis as needed. Excavations that do not comply with these requirements should be shored. Excavation walls in sands and dry soils must be kept moist at all times, but not saturated.

The horizontal distance of vertical surcharge loads from excavations should be at least 5 feet or half the excavation depth, whichever is greater. Some sloughing from granular soils may occur in excavations. Workers should be adequately protected from such sloughing, i.e., using movable shields/shoring. Surface drainage should be controlled along the top of excavation slopes.

Excavations for footings should be setback from the toe of temporary excavation slopes a horizontal distance equal to the footing excavation depth. The bases of excavations and trenches should be firm and unyielding prior to construction of foundations or installation of utilities. On-site materials, other than topsoil or soils with roots or deleterious materials may be used for backfilling of excavations.

12.2 Utility Trench Backfill

Utility trench backfill should be compacted at least to 95 percent of Maximum Dry Density (MDD), per ASTM Test Method D1557. Compaction shall be performed with a mechanical compaction device in accordance with specifications for trench backfill presented in **Appendix E**. If the excavated soils have dried, they should be moisture-conditioned to near

Optimum Moisture Content prior to placement and compaction in trenches. Trench backfill within building footprints must comply with all PCC floor slab moisture requirements.

Bedding material placed around utility conduits shall consist of clean gravel or sand with a Sand Equivalent (per ASTM D2419) of 30 or greater. Compaction of bedding material shall be in accordance with “Standard Specifications for Public Works Construction” (Greenbook) specifications. Jetting should not be employed for compaction of bedding material at depths less than 4 feet beneath the subgrade of concrete slabs-on-grade, vehicle pavements, or other structures.

12.3 Concrete Flatwork/Hardscape

The following recommendations for concrete flatwork and hardscape elements are not required; however, these recommendations are provided to minimize settlement and/or cracking, to extend the design life of the pavements, and to minimize future maintenance costs.

- Portland Cement Concrete sidewalks that will not support vehicular traffic should be at least 4 inches thick, and as a minimum, should be reinforced at mid-depth with 6x6-W1.4xW1.4 welded wire-fabric reinforcement.
- Based on a very low expansion potential, PCC sidewalks may be cast directly on compacted soil subgrades.
- The soil subgrade should be moisture conditioned at least to Optimum Moisture Content and compacted to at least 95 percent of Maximum Dry Density (per ASTM D1557). The moisture conditioned subgrade should not be allowed to desiccate prior to casting of concrete hardscape elements.
- To help minimize shrinkage cracking, concrete flatwork should be constructed using uniformly cured, low-slump concrete, with crack control joints spaced at intervals not exceeding 8 ft.

13.0 TENTATIVE PAVEMENT DESIGN AND ASSOCIATED GRADING

13.1 Asphalt Concrete Pavements

Design of asphalt concrete pavement sections depends primarily on support characteristics (strength) of soil beneath the pavement section and on cumulative traffic loads within the service life of the pavement. Strength of the pavement subgrade is represented by R-Value test data. Traffic loads within service life of a pavement are represented by a Traffic Index (TI) which is calculated based on anticipated traffic loads and on the projected number of load repetitions during the design life of the pavement. The design TI value should be

verified by the Project Civil Engineer prior to construction.

Based on soil type and compaction characteristics of future subgrade soils, and on judgment regarding variability of site soils, a preliminary design R-Value of 30 was selected. Pavement sections are provided in the following table. These sections satisfy the minimum requirements of the CALTRANS flexible pavement design procedure for the design R-Value and a design service life of 20 years.

Table 7 – Flexible Pavement Sections

TRAFFIC INDEX (TI)	PAVEMENT SECTION (THICKNESS IN INCHES)	
	ASPHALT CONCRETE	BASE COURSE
4	3.0	4.5
5	3.0	5.5
6	4.0	7.0
7	4.5	8.5
8	5.0	11.0

The preceding pavement sections provide the minimum thickness of asphalt concrete permitted by the Caltrans design procedure. Alternate designs with greater asphalt thickness and smaller base course thickness can be provided upon request.

13.2 PCC Vehicle Pavements

The design of PCC pavement and slab thicknesses and reinforcement is under the purview of a structural engineer. Deflections, shears, and moments in PCC pavements may be estimated using a coefficient of vertical subgrade reaction, k_v . The value k_v is defined as the pressure applied by the PCC slab divided by the resulting settlement of the subgrade and is a function of the subgrade soil type, soil stiffness, base thickness, and base type. An effective k_v value of 120 pci may be used for design of PCC pavements that support vehicle loads.

Unless specifically designed by the project structural engineer, PCC vehicle pavements should be at least 6 inches thick and reinforced with No. 3 rebar placed 18 inches on center in each horizontal direction. PCC vehicle pavements should be supported on at least 6 inches of compacted base material.

PCC apron slabs planned for support of heavy vehicle loads in loading areas should be reinforced with #4 bars at 14-inch spacing in both horizontal directions. PCC apron slabs should be at least 8-inches thick and should be supported on at least 8 inches of compacted base material.

13.3 PCC Curb and Gutter

Based on the anticipated expansion potential of the compacted fills at the project site (i.e., very low), proposed PCC curbs and gutters may be cast directly on compacted soil subgrades.

13.4 Base Course

The base course beneath pavements should have an R-value of at least 78 and should comply with specifications for untreated crushed aggregate base (CAB), crushed miscellaneous base (CMB), or processed miscellaneous base (PMB), as defined in Section 200-2 of the current **Green Book** (Standard Specifications for Public Works Construction), or aggregate base (AB-Class 2) as defined in Section 605.3 of the current Caltrans Highway Design Manual.

13.5 Grading Recommendations for Pavement Construction

13.5.1 General

All grading shall be performed under the observation and testing of the Project Geotechnical Engineer and/or their authorized representatives in accordance with the recommendations contained herein and in accordance with the current Building Code requirements of the County of Los Angeles.

In order to provide suitable bearing support for the pavement section, all disturbed compacted fill soils (e.g. due to desiccation or over-saturation by rainfall, broken water lines, etc.) must be removed and replaced with a minimum 12 inches of fill compacted to the required density and moisture content before placement of base and asphalt concrete.

13.5.2 Subgrade Preparation

The top 6 inches of the sub-grade materials shall be scarified and moisture conditioned to Optimum Moisture Content, or above, immediately prior to pavement construction. The moisture content shall be brought to the specified percentage by the addition of water, by the addition and blending of dry suitable material, or by the drying of existing material. The subgrade material shall then be compacted to a relative compaction of at least 95 percent of Maximum Dry Density, per ASTM 1557.

During processing of the top 6 inches of backfill in the pavement subgrade, all rocks larger than 3 inches in dimension shall be removed. If unsuitable material is found below the processing depth, it shall be removed and replaced as compacted fill. After compaction and trimming, the subgrade shall be firm, hard, and unyielding.

13.5.3 Placement of Base Materials

Base material shall be watered as required to facilitate compaction and spread and

compacted in horizontal lifts of approximately equal thickness. The maximum compacted thickness of any aggregate base lift shall not exceed 6 inches. Each lift of aggregate base material shall be compacted to at least 95 percent of Maximum Dry Density, per ASTM D1557.

14.0 LOS ANGELES COUNTY 111 STATEMENT

In compliance with Section 111 of the Los Angeles County Building Code, it is the finding of this firm that the proposed improvements designated on the Geotechnical Map submitted with this report, will be safe against hazard from landslide, settlement, and slippage, for the use intended, and will not affect offsite property, provided that all our recommendations are incorporated in the Grading and Building Plans and implemented during construction.

15.0 PLAN REVIEW AND CONSTRUCTION OBSERVATIONS

Allan E. Seward Engineering Geology, Inc. (AESEGI) should be authorized to review project grading plans, foundation plans and specifications for conformance with the recommendations provided in this report. Prior to the approval of the Grading Plans and Building Plans by the County of Los Angeles, this office is required to review and approve your plans by manual signatures and date.

AESEGI should also be authorized to perform on-site construction observation and testing to ascertain that conditions at the project site are consistent with the findings and conclusions presented in this report and that construction operations are performed in accordance with the recommendations presented in this report. If variations in subsurface soil conditions become evident during construction, the recommendations presented in this report may require revision.

The geotechnical and geological consultants of record should be authorized to perform the testing and observation recommended in this report, including the following tasks:

1. Observation and testing of all subgrade and fill bottoms (following excavation and prior to scarifying, recompaction, and fill placement).
2. Observation and testing of all fill placement and compaction.
3. Observation of foundation excavations to verify embedment into competent bearing material (prior to placement of forms or reinforcement into the excavations). Excavations must be free of all loose and slough material and must be neatly trimmed and water-conditioned prior to casting concrete in them.
4. Observation and testing of utility trenches beneath and adjacent to the proposed structures

5. Observation of slab-on-grade subgrades prior to casting of concrete and/or installation of slab underlayment materials. The slab subgrades must be tested to verify that they have been maintained at the moisture content recommended herein.

Please notify AESEGI at least 48 hours in advance of any required observations, sampling, or testing, so that appropriate personnel can be made available.

16.0 GEOLOGIST/GEOTECHNICAL ENGINEER OF RECORD

This report has been prepared assuming that all required geologic and geotechnical field inspections and observations will be performed by Allan E. Seward Engineering Geology, Inc. If these tasks are performed by another party, that party must review this report, assume full responsibility for recommendations contained herein, and assume the title and responsibility of “Geologist/Geotechnical Engineer of Record” for the specific work.

A representative of the Geologist/Geotechnical Engineer of Record shall be present to observe all grading operations. All footing excavations shall be observed by a representative of the Geologist/Geotechnical Engineer of Record prior to placing steel or casting concrete in the excavations. A report that presents results of these observations and related testing shall be issued at the end of grading operations.

17.0 LIMITATIONS

This report has been prepared by Allan E. Seward Engineering Geology, Inc. for the exclusive use of Union Rescue Mission and their design consultants for the specific site discussed herein. This report should not be considered transferable. Prior to use by others, this firm must be notified, as additional work may be required to update this report.

In the event that any modification in the location or design of the proposed development, as discussed herein, are planned, the conclusions and recommendations contained in this report will require a written review by this firm with respect to the planned modifications.

The proposed development is located in southern California, a geologically and tectonically active region, where large magnitude, potentially destructive earthquakes are common. Therefore, ground motions from moderate or large magnitude earthquakes could affect the project site during the design life of the proposed structure(s).

In performing these professional services, this firm has used the degree of care and skill ordinarily exercised under similar circumstances by reputable engineering geologists and geotechnical engineers practicing in this or similar localities. The data presented in this report are based on the results of pertinent field and laboratory testing. It should be recognized that subsurface conditions can vary in time and laterally and with depth at a given site and that the

conclusions and recommendations presented in this report are based on our interpretation of these data. Therefore, our **conclusions** and **recommendations** are **professional opinions** and are **not meant** to be a control of nature. We make no other **warranty**, either **expressed** or **implied**.

This opportunity to be of service is appreciated. If you have any questions regarding this report, please contact us.

Respectfully submitted,



Eric J. Seward, CEG 2110
Principal Engineering Geologist
Vice President



Kevin P. Callahan, MS, GE 2989
Principal Geotechnical Engineer



The following attachments and appendices complete this report.

Location Map

following page 3

Geologic Map by Dibblee

following page 7

References

APPENDIX A – Subsurface Logs and Infiltration Test Reports

- Exploratory Boring Logs (HS-1 thru HS-5)
- Key to Boring Log Symbols
- Boring Percolation Test Reports

Figures A1 and A2

APPENDIX B – Laboratory Testing

APPENDIX C – Seismicity

- Earthquake Zones of Required Investigation
- Fault and Earthquake Epicenter Location Map
- OSHPD Seismic Design Maps Output
- USGS Deaggregation Parameters and Output
- Magnitude-Distance Contributions to Hazard

Figure C1

Figure C2

Figure C3

- Site-Specific Response Spectra and Seismic Design Parameters Figure C4
- Ground Motion Hazard Analysis Calculations (4 pages)
- Ground Motion and Response Spectra References

APPENDIX D – Liquefaction Evaluation

- SPT-Based Assessment of Seismic Soil Liquefaction Potential Figure D1
- Corrections for Standard Penetration Test (1 page)
- Seismic Soil Liquefaction Triggering Calculations (2 pages)
- Seismically-Induced Settlement Calculations (2 pages)
- References for Assessment of Liquefaction Potential and Estimated Cyclic Settlements

APPENDIX E – General Specifications, Figures, Map and Cross Sections

- Recommended Earthwork Specifications
- Recommended Specifications for Placement of Trench Backfill
- Drainage and Erosion Control Recommendations
- Retaining Wall Drainage Detail
- Alternate Retaining Wall Drainage Detail

Geotechnical Map

Plate I

Cross Sections 1-1' and 2-2'

Plate II

Distribution:

Union Rescue Mission
Mr. Kevin Dretzka

(via email in PDF format)

Land Design Consultants, Inc.
Mr. Steve Hunter

(via email in PDF format)

REFERENCES

Published

- Bilodeau, W.L., Bilodeau, S.W., Gath, E.M., Osborne, M., Proctor, R.J., 2007, Geology of Los Angeles, California, United States of America: Environmental & Engineering Geoscience, Vol. XIII, No. 2, May, p. 99-160.
- California Building Standards Commission, 2019, California Building Code (CBC): California Code of Regulations, Title 24, Part 2, Volumes 1 and 2
- California Department of Conservation, California Geological Survey (CGS), 2008, Guidelines for Evaluating and Mitigating Seismic Hazards in California, Special Publication 117A.
- California Geological Survey, 2018, Earthquake Zones of Required Investigation web application, <https://maps.conservation.ca.gov/cgs/EQZApp/>
- California Department of Conservation, Division of Mines and Geology (CDCEMG), 1998, Seismic Hazard Zone Report for the San Fernando 7.5-Minute Quadrangle, Los Angeles County, California, Seismic Hazard Zone Report 015.
- California Department of Conservation, Division of Oil, Gas & Geothermal Resources (DOGGR), 2018, Online Well Finder system, <http://www.conservation.ca.gov/dog/Pages/WellFinder.aspx>.
- County of Los Angeles, Code of Ordinances: 2020 Los Angeles County Code, Volume 7, Title 26 - Building Code
- County of Los Angeles, Department of Public Works, Geotechnical and Materials Engineering Division, 2017, Administrative Manual GS200.2, Guidelines for Geotechnical Investigation and Reporting Low Impact Development Storm Water Infiltration, June 30.
- County of Los Angeles, Department of Public Works, Geotechnical and Materials Engineering Division, 2013, Manual for Preparation of Geotechnical Reports, July 1.
- County of Los Angeles, Department of Public Works, Online Groundwater Well Data, <http://dpw.lacounty.gov/general/wells/>
- Dibblee, T.W., Jr., 1991, Geologic Map of the San Fernando and Van Nuys (North ½) Quadrangles, Los Angeles County, California, Dibblee Geological Foundation Map DF-33, scale 1:24,000.
- Hart, E.W. and Bryant W.A., 1997, Fault-rupture hazard zones in California: California Division of Mines and Geology Special Publication, 42, 38 p.
- Jennings, C.W., 1988, Fault map of California with locations of volcanoes, thermal springs, and thermal wells: California Division of Mines and Geology, Geologic Data Map No. 1, 4th printing; scale 1:750,000.
- Jennings, C.W., 1994, Fault activity map of California and adjacent areas, with locations and ages of recent volcanic eruptions: California Division of Mines and Geology, California Geologic Map Series Map No. 6; scale 1:750,000
- Leighton & Associates, Inc., 1990, L.A. County General Plan - Safety Element, including technical appendices: Volumes 1 and 2.
- Munger, K.R., ed., 2003, Munger Map Book, California and Alaska Oil and Gas Fields: Forty Second Edition, August 2003.
- Peabody, A.W., 1969, Principles of cathodic protection, Chapter 5, NACE Corrosion Course: National Academy of Corrosion Engineers.
- University of Southern California (USC), Southern California Earthquake Center (SCEC), Workshop on "Recommended Procedures for Implementation of DMG Special Publication 117, Guidelines for Analyzing and Mitigating Liquefaction in California", USC, Los Angeles, California, June 17, 1999.

REFERENCES

Report by Foundation Engineering Company, Inc.

- 1) Foundation Investigation Report**
Skilled Nursing Facility
Forester Haven
12249 N. Lopez Canyon Road
San Fernando, California
Dated December 27, 1974

Appendix A

CLIENT: Union Rescue Mission	JOB NO.: 20-2563	DRILL HOLE LOG
PROJECT: URM Hope Gardens - Sequoia Building 12249 Lopez Canyon Road, Sylmar CA	DATE: October 14, 2020	
DRILLING COMPANY: Choice Drilling, Inc.	LOGGED BY: KPC	
DRILLING METHOD: Hollow-stem Auger	DRILLED: 8/27/20	
HAMMER TYPE: Automatic	HOLE DIA: 8"	
DRIVING WEIGHTS: 140 lbs	AVERAGE DROP: 18"	
	ELEVATION: 1427'	BORING NO. HS-1

DEPTH (feet)	SAMPLE TYPE	BLOWS / 12"	GRAPHIC LOG	USCS SYMBOL	DESCRIPTION	LABORATORY TESTS			
						Moisture Content (%)	Dry Density (pcf)	% Fines	Other Tests
0					ASPHALT; (0 - 4') ARTIFICIAL FILL; af (4" - 6')				
3		67		SP-SM	@ 3' Poorly graded SAND with silt; medium dense; very moist; light brown				
4					@ 4' - with gravel; dense; very moist; dark gray	9.3	125		
6		15		SM	QUATERNARY ALLUVIUM; Qal (6 - 23') @ 6' Silty SAND with gravel; medium dense; damp; light brown				
9		28		SP-SM	@ 9' Poorly graded SAND with silt and gravel; medium dense; damp; medium brown	3.4	116	9	Swell/Consol Shear Test
12		26		SM-SC	@ 12' Silty, clayey SAND; medium dense; slightly moist; medium brown				
12.5				SP-SM	@ 12.5' Poorly graded SAND with silt and gravel; medium dense; damp; medium to yellowish brown				
15		18		SC	@ 15' Clayey, fine- to coarse-grained SAND with gravel; medium dense; slightly moist; medium brown	8.7	120		
22.5					@ 22.5' - dense gravel/cobble layer BEDROCK; TQs (23 - 30')				
25	Ref/5"				@ 25' Silty, medium- to coarse-grained sandstone; very dense; damp; light brownish-gray	9.1	113		
30	50/4"				@ 25' - fine-grained; medium brown				
					TOTAL DEPTH 30' (Elev. 1397') No Groundwater				

CLIENT: Union Rescue Mission	JOB NO.: 20-2563	DRILL HOLE LOG
PROJECT: URM Hope Gardens - Sequoia Building 12249 Lopez Canyon Road, Sylmar CA	DATE: October 14, 2020	
DRILLING COMPANY: Choice Drilling, Inc.	LOGGED BY: KPC	
DRILLING METHOD: Hollow-stem Auger	DRILLED: 8/27/20	
HAMMER TYPE: Automatic	HOLE DIA: 8"	
DRIVING WEIGHTS: 140 lbs	AVERAGE DROP: 18"	
	ELEVATION: 1430'	BORING NO. HS-2

DEPTH (feet)	SAMPLE TYPE	BLOWS / 12"	GRAPHIC LOG	USCS SYMBOL	DESCRIPTION	LABORATORY TESTS			
						Moisture Content (%)	Dry Density (pcf)	% Fines	Other Tests
0					ASPHALT; (0 - 6")				
					QUATERNARY ALLUVIUM; Qal (6" - 25.5')				Bulk sample @ 0-10'
9		9		SM	@ 3' Silty, fine- to medium-grained SAND; loose; damp; dark brownish-gray to medium brown; scattered pebbles				
21		21			@ 6' - fine-grained; medium dense; slightly moist; dark brownish gray	6.7	109		
11		11			@ 9' - medium brown				
10					@ 10' - less silty; dark brownish gray				
63		63		SP	@ 12' Poorly graded SAND with gravel; dense; damp; medium brown to yellowish brown to medium gray	2.2	123		
15		22		SM	@ 15' Silty, fine- to medium-grained SAND; medium dense; moist; dark brown				
				SP-SM	@ 16' Poorly graded SAND with silt; medium dense; damp; light yellowish brown; minor gravel				
20	Ref/ 6"				@ 20' - with gravel and small cobbles; moist; medium brown				
25	50/4"				BEDROCK; TQs (25.5 - 30')				
					@ 25.5' Silty sandstone; very dense; damp; pale yellowish brown				
30	Ref/ 3" Ref/ 4"				TOTAL DEPTH 30' (Elev. 1400') No Groundwater				
35									

CLIENT: Union Rescue Mission	JOB NO.: 20-2563	DRILL HOLE LOG
PROJECT: URM Hope Gardens - Sequoia Building 12249 Lopez Canyon Road, Sylmar CA	DATE: October 14, 2020	
DRILLING COMPANY: Choice Drilling, Inc.	LOGGED BY: KPC	
DRILLING METHOD: Hollow-stem Auger	DRILLED: 8/28/20	
HAMMER TYPE: Automatic	HOLE DIA: 8"	
DRIVING WEIGHTS: 140 lbs	AVERAGE DROP: 18"	
	ELEVATION: 1428'	BORING NO. HS-3

DEPTH (feet)	SAMPLE TYPE	BLOWS / 12"	GRAPHIC LOG	USCS SYMBOL	DESCRIPTION	LABORATORY TESTS			
						Moisture Content (%)	Dry Density (pcf)	% Fines	Other Tests
0			ASPHALT		ASPHALT; (0 - 4")				
			QUATERNARY ALLUVIUM		QUATERNARY ALLUVIUM; Qal (4" - 16')				
3		33	SAND	SP-SM	@ 3' Poorly graded SAND with silt and gravel; medium dense; damp; light yellowish brown				
6		56	SAND		@ 6' - very dense				
9		68	SAND		@ 9' - dense	1.8	126		
12		55	SAND		@ 12' - less gravel; very dense				
16		50/4'	SAND		@ 16' - refusal				
TOTAL DEPTH 16' (Elev. 1412')									
No Groundwater									

CLIENT: Union Rescue Mission	JOB NO.: 20-2563	DRILL HOLE LOG
PROJECT: URM Hope Gardens - Sequoia Building 12249 Lopez Canyon Road, Sylmar CA	DATE: October 14, 2020	
DRILLING COMPANY: Choice Drilling, Inc.	LOGGED BY: KPC	
DRILLING METHOD: Hollow-stem Auger	DRILLED: 8/27/20	
HAMMER TYPE: Automatic	HOLE DIA: 8"	
DRIVING WEIGHTS: 140 lbs	AVERAGE DROP: 18"	
	ELEVATION: 1423'	BORING NO. HS-4

DEPTH (feet)	SAMPLE TYPE	BLOWS / 12"	GRAPHIC LOG	USCS SYMBOL	DESCRIPTION	LABORATORY TESTS			
						Moisture Content (%)	Dry Density (pcf)	% Fines	Other Tests
0					ASPHALT/BASE; (0 - 4") ALLUVIUM; Qal (4" - 32.5')				Bulk sample @ 0-10'
5		37		SP-SM	@ 5' Poorly graded SAND with silt and gravel; dense; damp; light grayish brown	2.3		7	
		88			@ 7.5' - very dense; damp; light gray; gravel is abundant	1.4		8	Resistant layer and difficult drilling conditions from approx. 7-12 ft
10	Ref/ 6"					1.7		9	
		26		SP-SM	@ 12.5' - less gravel; medium dense; light yellowish brown	2.4		12	Sieve
15		39			@ 15' - with gravel; dense	2.2		8	
		50				2.3		7	
20		41			@ 20' - less gravel	2.6		7	
		30			@ 22.5' - medium dense	3.6		9	
25		29				4.6		9	
		35		SM	@ 27.5' Silty SAND; dense; damp; light yellowish brown	8.0		14	
					@ 29' - moist to wet				
30		76		SP-SM	@ 30' Poorly graded SAND with silt; very dense; wet; light yellowish brown	11.4		10	
		66			BEDROCK; TQs (32.5 - 37.5') @ 32.5' Claystone with sand; hard; moist; medium to reddish brown	16.3		72	
35	Ref/ 6"				@ 35' Clayey sandstone; very dense; moist; medium brown	10.0		43	
		95/ 10"			@ 37.5' Sandy claystone; hard; moist; medium brown				
					TOTAL DEPTH 37.5' (Elev. 1385.5') Perched Groundwater at 29'	13.8		54	

CLIENT: Union Rescue Mission	JOB NO.: 20-2563	DRILL HOLE LOG
PROJECT: URM Hope Gardens - Sequoia Building 12249 Lopez Canyon Road, Sylmar CA	DATE: October 14, 2020	
DRILLING COMPANY: Choice Drilling, Inc.	LOGGED BY: KPC	
DRILLING METHOD: Hollow-stem Auger	DRILLED: 8/27/20	
HAMMER TYPE: Automatic	HOLE DIA: 8"	
DRIVING WEIGHTS: 140 lbs	AVERAGE DROP: 18"	
	ELEVATION: 1418'	BORING NO. HS-5

DEPTH (feet)	SAMPLE TYPE	BLOWS / 12"	GRAPHIC LOG	USCS SYMBOL	DESCRIPTION	LABORATORY TESTS			
						Moisture Content (%)	Dry Density (pcf)	% Fines	Other Tests
0					ASPHALT/BASE; (0 - 9")				
					ALLUVIUM; Qal (9" - 25.5')				
9				SM	@ 3' Silty, fine- to medium-grained SAND; loose; damp; medium brown				
19					@ 6' - with gravel; medium dense	6.4	116		
22					@ 9' - less gravel				
22				SP-SM	@ 10' Poorly graded SAND with silt; medium dense; moist; light brown				
19				SW-SM	@ 12' Well-graded SAND with silt; medium dense; moist; light brown	3.5	111	7	Sieve Swell/Consol
15									
19									
20				SP-SM	@ 20' Poorly graded SAND with silt and gravel; medium dense; moist; light brown	6.9	116		
25		50/6"			@ 25' - wet BEDROCK; TQs (25.5 - 26') @ 25.5' Sandy mudstone; hard; damp; grayish white				
					TOTAL DEPTH 26' (Elev. 1392') Perched Groundwater @ 25'				

SOIL CLASSIFICATION CHART

MAJOR DIVISIONS		SYMBOLS		TYPICAL DESCRIPTIONS		
		GRAPH	LETTER			
COARSE GRAINED SOILS	GRAVEL AND GRAVELLY SOILS	CLEAN GRAVELS (LITTLE OR NO FINES)		GW	Well-graded gravels, gravel-sand mixtures, little or no fines	
				GP	Poorly-graded gravels, gravel-sand mixtures, little or no fines	
		MORE THAN 50% OF COARSE FRACTION RETAINED ON NO. 4 SIEVE SIZE	GRAVELS WITH FINES (APPRECIABLE AMOUNT OF FINES)		GM	Silty gravels, gravel-sand-silt mixtures
				GC	Clayey gravels, gravel-sand-clay mixtures	
	SAND AND SANDY SOILS			CLEAN SANDS (LITTLE OR NO FINES)		SW
			SP		Poorly-graded sands, gravelly sands, little or no fines	
		MORE THAN 50% OF MATERIAL IS LARGER THAN NO. 200 SIEVE SIZE	MORE THAN 50% OF COARSE FRACTION PASSING ON NO. 4 SIEVE SIZE	SANDS WITH FINES (APPRECIABLE AMOUNT OF FINES)		SM
					SC	Clayey sands, sand-clay mixtures
	FINE GRAINED SOILS				SILTS AND CLAYS	LIQUID LIMIT LESS THAN 50
			CL	Inorganic clays of low to medium plasticity, gravelly clays, sandy clays, lean clays		
		OL	Organic silts and organic silty clays of low plasticity			
SILTS AND CLAYS		LIQUID LIMIT GREATER THAN 50		MH	Inorganic silts, micaceous or diatomaceous fine, sandy or silty soils, elastic silts	
				CH	Inorganic clays of high plasticity, fat clays	
				OH	Organic clays of medium to high plasticity, organic silts	
HIGHLY ORGANIC SOILS				PT	Peat and other highly organic soils	

HS: Hollow-stem-auger boring
 RW: Rotary-wash boring
 B: Bucket-auger boring

SAMPLE TYPE

- STANDARD PENETRATION TEST
Split barrel sampler in accordance with ASTM D-1586 Test Method
- CALIFORNIA DRIVE
Split-barrel sampler in accordance with ASTM D-3550 Test Method
- DISTURBED CALIFORNIA DRIVE
- SHELBY TUBE
Thin-walled sampler in accordance with ASTM D-1587 Test Method
- BULK SAMPLE
- NO RECOVERY

GROUND WATER DATA

- GROUND WATER WHILE DRILLING
- GROUND WATER AFTER DRILLING

DENSITY OF GRANULAR SOILS	
DESCRIPTION	SPT BLOWS PER FOOT
Very Loose	< 4
Loose	4 - 10
Medium Dense	11 - 30
Dense	31 - 50
Very Dense	> 50

STRENGTH OF COHESIVE SOILS	
CONSISTENCY	SPT BLOWS PER FOOT
Very Soft	< 2
Soft	2 - 4
Firm	5 - 8
Stiff	9 - 15
Very Stiff	16 - 30
Hard	> 30

SPLIT-BARREL SAMPLER DRIVING RECORD	
BLOW COUNT	DESCRIPTION
25	25 blows drove the sampler 12 inches, after initial 6 inches of seating
50/7"	50 blows drove the sampler 7 inches, after initial 6 inches of seating
Ref/3"	50 blows drove the sampler 3 inches during initial 6-inch seating interval

LABORATORY TESTING ABBREVIATIONS			
Plasticity Index	PI	Compaction Curve	Curve=A
Liquid Limit	LL	Consolidation / Collapse	Consol
Hydrometer	%-5 micron	Direct Shear / Reshear / Remold	Shear Test
Expansion Index	EI		
Corrosivity Analysis	Cor		

Notes:

- (1) Dual USCS symbols, such as SP-SM, denote 5 to 12% of minor constituent.
- (2) Dual USCS symbols, such as SM/ML, denote borderline soil classifications.
- (3) Subsurface information from boring and test pit logs depict conditions only at the specific locations and dates indicated. Soil conditions and water levels at other locations may differ from conditions at these locations. Also, the conditions at these locations may change with time.
- (4) Blow counts on logs are the number of blows to drive the sampler with the weight and drop height indicated on each log.
- (5) Split-barrel sampler driving record applies only to hollow-stem-auger and rotary-wash borings.
- (6) These logs are subject to the limitations, conclusions, and recommendations in this report.



ALLAN E. SEWARD
ENGINEERING GEOLOGY, INC.
 Geological and Geotechnical Consultants

USCS Soil Classification and Key to Boring Log Symbols



ALLAN E. SEWARD

ENGINEERING GEOLOGY, INC.
GEOLOGICAL AND GEOTECHNICAL CONSULTANTS

BORING PERCOLATION TEST REPORT

CONSTANT HEAD

Client: Union Rescue Mission	Borehole Depth [ft]: 12
Project: URM Hope Gardens - Sequoia Building 12249 Lopez Canyon Road, Sylmar	Borehole Diameter [in]: 8
	Seasonal High GW Elev.: <1401
Project No.: 20-2653	Test Invert Elevation: 1411
Test Date: 8/28/20 Test By: K. Callahan	Soil Type at Invert: Qal
Location: PB-1	USCS Soil Type at Invert: SP-SM

Test Start Time: 2:00 PM	Stabilized flow rate [in ³ /min]: 12
Standard Time Interval (min): 10	Total volume infiltrated [in ³]: 1589
Test Duration (min): 100	Total Reduction Factor: 4.5
Water Remaining after 24 hr?: No	Design Infiltration Rate (in/hr): 0.24

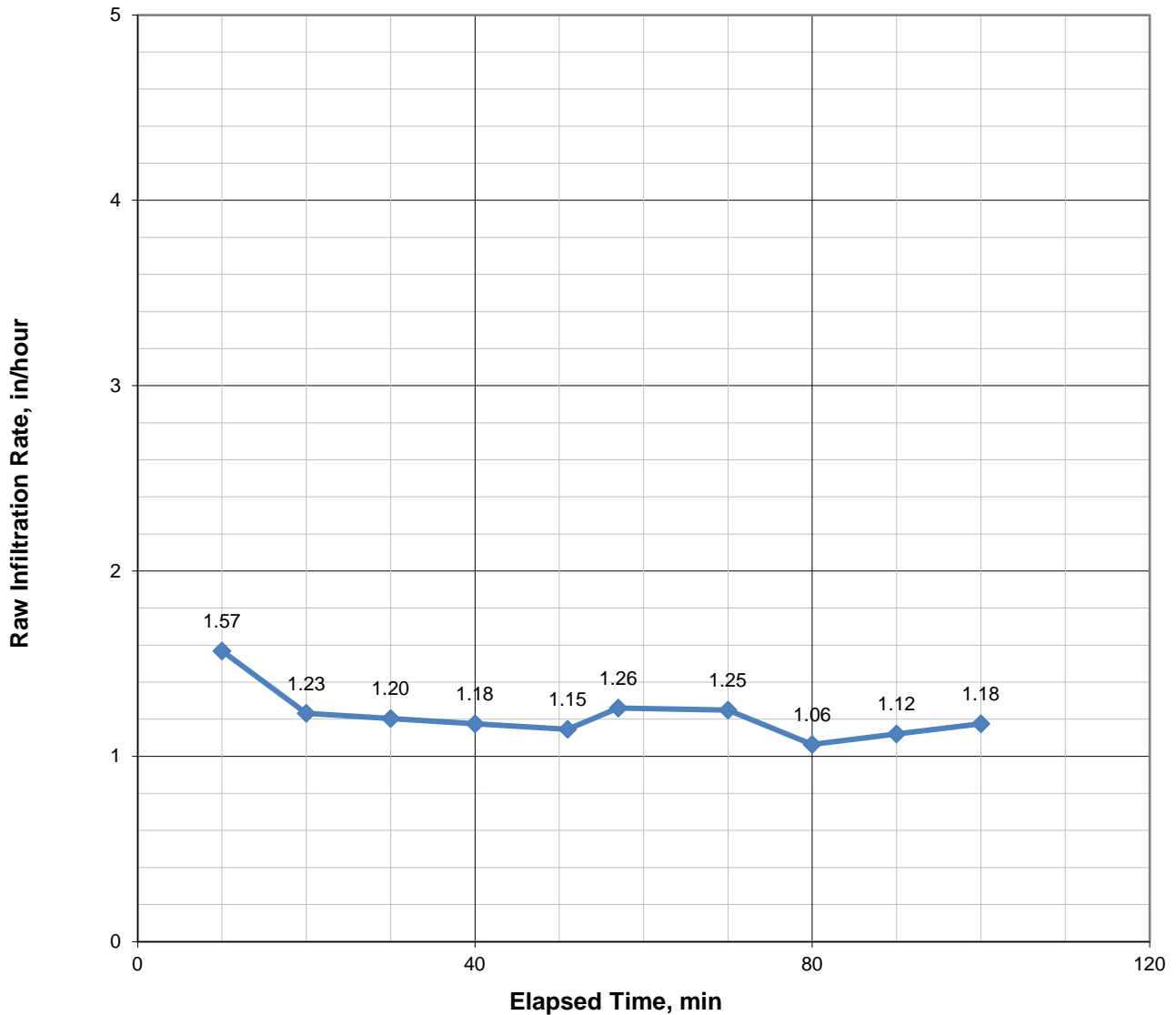

Figure A1



ALLAN E. SEWARD

ENGINEERING GEOLOGY, INC.
GEOLOGICAL AND GEOTECHNICAL CONSULTANTS

BORING PERCOLATION TEST REPORT

CONSTANT HEAD

Client: Union Rescue Mission	Borehole Depth [ft]: 12
Project: URM Hope Gardens - Sequoia Building 12249 Lopez Canyon Road, Sylmar	Borehole Diameter [in]: 8
	Seasonal High GW Elev.: <1396
Project No.: 20-2653	Test Invert Elevation: 1406
Test Date: 8/28/20 Test By: K. Callahan	Soil Type at Invert: Qal
Location: PB-2	USCS Soil Type at Invert: SW-SM

Test Start Time: 2:00 PM	Stabilized flow rate [in ³ /min]: 80
Standard Time Interval (min): 10	Total volume infiltrated [in ³]: 9086
Test Duration (min): 100	Total Reduction Factor: 4.5
Water Remaining after 24 hr?: No	Design Infiltration Rate (in/hr): 1.63

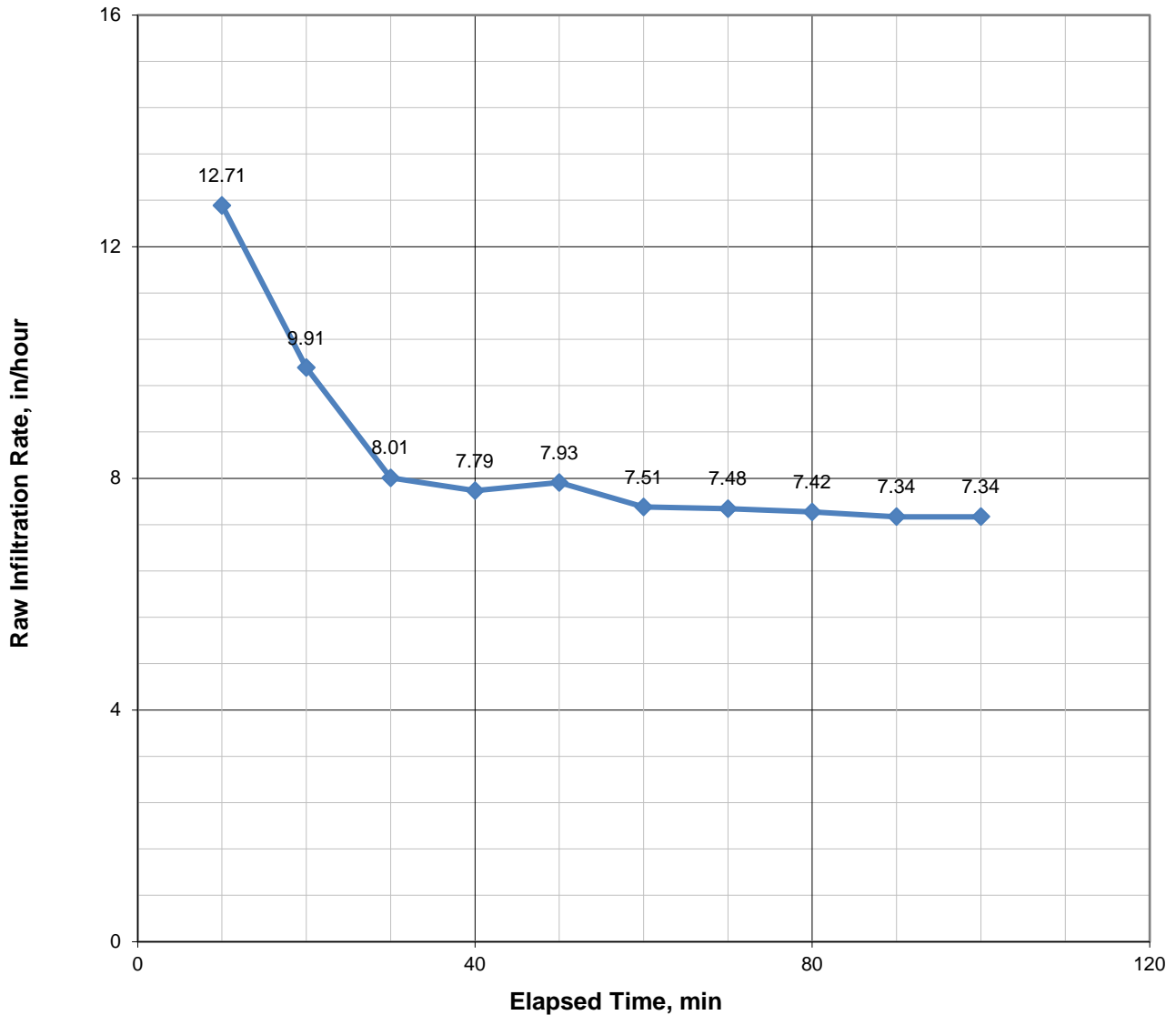

Figure A2

Appendix B

APPENDIX B

GEOTECHNICAL LABORATORY INVESTIGATION

1. General

- a. The laboratory investigation used current, accepted test procedures of the American Society of Testing and Materials (ASTM) and/or California Test Standards, wherever practical.
- b. Bulk samples and Modified California Drive ring samples were obtained during the field investigation. Laboratory sample identification is by project name and number, boring number, and depth.

2. Geotechnical Index Parameter Tests

The following Geotechnical Index Parameters tests were performed on bulk samples and Modified California ring samples of soil collected at the project site.

TEST TYPE	NUMBER OF TESTS PERFORMED	TESTING STANDARD
In-Situ Moisture Content	24	ASTM D2216
In-Situ Dry Density	10	ASTM D7263
Percent-Finer Than #200 Sieve	18	ASTM D1140
Particle-Size Analysis of Soils	2	ASTM D

The purpose of each test type is briefly described below.

- a. In-Situ Moisture Content (ASTM D2216) and Dry Density (ASTM D7263) testing of soils provide an indication of the strength and compressibility of in-situ soils. These data aided in evaluation of soil consistency and in selection of samples for additional laboratory testing. Results of Moisture Content and Dry Density testing are recorded on the Drill Hole Logs in **Appendix A**.
- b. Percent Finer than #200 Sieve (ASTM D1140) testing aids in classification of soils in accordance with the Unified Soil Classification System (USCS). Results of Percent Finer than #200 Sieve testing are recorded on the Drill Hole Logs in **Appendix A** and on applicable test reports in this appendix.
- c. Mechanical particle-size analyses of soil fractions larger than 75 microns (No. 200 sieve) were conducted to aid in classification of soils in accordance with the Unified Soil Classification System (USCS). Results of the Particle Size Analysis testing are presented on Lab Report Figure B1 in this Appendix.

APPENDIX B

3. Geotechnical Engineering Parameters Tests

The following Geotechnical Engineering Parameters Tests were performed on bulk samples and Modified California ring samples of soil collected at the project site.

TEST TYPE	NUMBER OF TESTS PERFORMED	TESTING STANDARD
Modified Proctor	1	ASTM D1557
Direct Shear	2	ASTM D3080
Consolidation	2	ASTM D4546

The purpose of each test type is briefly described below.

1. Modified Proctor (ASTM D1557) testing was performed on a selected bulk sample of site artificial fill soils to assess the compacted moisture-density relationship for use during future grading operations and to evaluate the relative compaction of the existing soils. Results of the Modified Proctor test is presented on **Figure B2** in this Appendix.
2. Direct Shear (ASTM D3080) testing was performed on selected ring samples and on remolded test specimens using a displacement-controlled Direct Shear machine. The remolded sample was prepared using material passing the No. 4 sieve compacted to about 90% of Maximum Dry Density. Prior to testing, the samples were inundated and consolidated under normal pressures ranging from about 500 psf to 3,000 psf. Thereafter, the samples were sheared horizontally at a controlled displacement rate until the horizontal shear force reduced to a stable value. Results of the Direct Shear testing, including interpreted peak strength and residual shear strength parameters, are recorded on **Figures B3.1** and **B3.2** in this Appendix.
3. One-dimensional Collapse of Soils (ASTM D4546) testing was performed on California drive ring samples to assess the hydro-compression potential of alluvial soils when inundated with water under future loading conditions. The samples were incrementally loaded to normal pressures ranging from 400 to 12,800 psf in accordance with Procedure B. The “hydro-compression” was taken as the percent strain when inundated with water under an applied pressure approximately equal to the existing overburden pressure plus future applied foundation bearing pressure at that depth. Results of collapse testing are presented on **Figures B4.1** and **B4.2** in this Appendix.

APPENDIX B

4. Corrosion Tests

The following corrosivity tests were performed on a blend of artificial fill and native soils collected at the project site.

TEST TYPE	NUMBER OF TESTS PERFORMED	TESTING STANDARD
Sulfate-Content	1	California Test Method 417
Chloride-Content	1	California Test Method 422
Resistivity	1	California Test Method 643
pH	1	California Test Method 643

Soluble Sulfates Content, Chloride Content, Resistivity, and pH tests were performed to evaluate corrosivity of soil from the project site to concrete, ferrous metals, and non-ferrous metals. Results of the testing are presented in **Table B1** in this Appendix.

The following attachments complete this Appendix.

LABORATORY TEST RESULTS

- Corrosivity Testing Summary Table B1
- Particle-Size Analysis Test Report Figure B1
- Compaction Test Report Figure B2
- Direct Shear Test Reports Figures B3.1 & B3.2
- Consolidation Test Reports Figures B4.1 & B4.2

APPENDIX B

CORROSIVITY TESTING SUMMARY

SOURCE	DEPTH (FT)	SOIL DESCRIPTION	RESISTIVITY		CHEMICAL ANALYSES			
			SATURATED (OHM-CM)	CORROSION CHARACTERISTICS ²	PH	CHLORIDE CL (PPM)	SULFATE SO ₄ (%)	CONCRETE EXPOSURE TO SULFATE ³
HS-2/HS-4	0-10	Silty Sand	9,518	Moderately Corrosive	7.81	186	0.02	Negligible

² Per County of Los Angeles classification

³ Per ACI 318 – Table 4.3.1

Particle Size Distribution Test Report

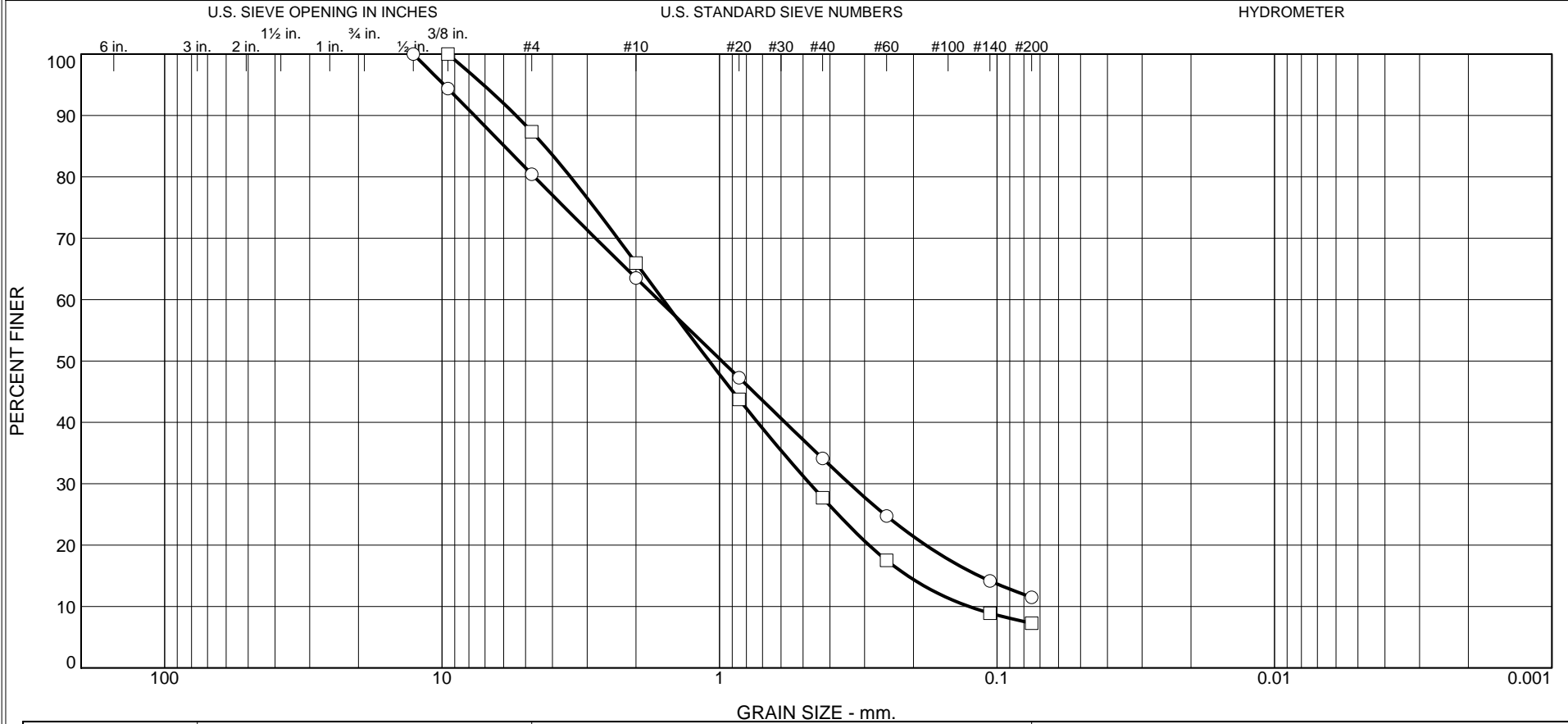

	% +3"	% Gravel		% Sand			% Fines	
		Coarse	Fine	Coarse	Medium	Fine	Silt	Clay
○	0.0	0.0	19.6	16.9	29.4	22.6	11.5	
□	0.0	0.0	12.7	21.3	38.3	20.4	7.3	

	Source	Sample #	Depth/Elev.	Date Sampled	USCS	Material Description	NM %	LL	PL
○	HS-4		13.5'	8/27/20	SP-SM	Poorly graded SAND with silt and gravel	2.4		NP
□	HS-5		13'	8/27/20	SW-SM	Well-graded SAND with silt	3.5		NP

Client Union Rescue Mission
 Project URM Hope Gardens - Sequoia Building
 12249 Lopez Canyon Road, Sylmar CA
 Project No. 20-2563 Figure B1

ALLAN E. SEWARD
ENGINEERING GEOLOGY, INC.
 Valencia, California

○ Alluvium (Qal)
 □ Alluvium (Qal)

COMPACTION TEST REPORT

Curve No.
A

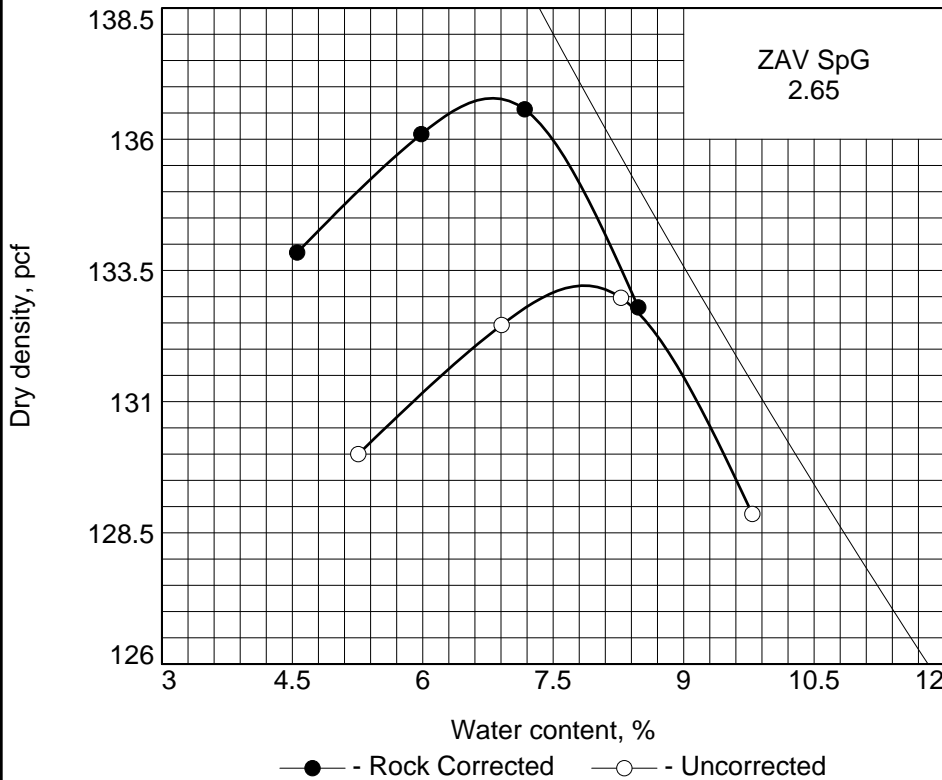

Test Specification:
ASTM D 1557-12 Method A Modified
ASTM D4718-15 Oversize Corr. Applied to Each Test Point

Preparation Method Moist
Hammer Wt. 10 lb.
Hammer Drop 18 in.
Number of Layers five
Blows per Layer 25
Mold Size 0.03333 cu. ft.

Test Performed on Material
Passing #4 **Sieve**

NM **LL** **PI**
Sp.G. (ASTM D 854) 2.65
%>#4 13.4 **%<No.200** 22.8

USCS SM **AASHTO**
Date Sampled 8/27/20
Date Tested 9/4/0
Tested By E. Parr

TESTING DATA

	1	2	3	4	5	6
WM + WS	8.91	9.07	9.15	9.06		
WM	4.37	4.37	4.37	4.37		
WW + T #1	760.8	949.1	919.9	842.0		
WD + T #1	724.3	889.9	852.9	770.8		
TARE #1	29.8	32.2	43.6	43.7		
WW + T #2						
WD + T #2						
TARE #2						
MOISTURE	4.6	6.0	7.2	8.5		
DRY DENSITY	133.8	136.1	136.6	132.8		

ROCK CORRECTED TEST RESULTS

Maximum dry density = 136.8 pcf
Optimum moisture = 6.8 %

Project No. 20-2563 **Client:** Union Rescue Mission
Project: URM Hope Gardens - Sequoia Building
12249 Lopez Canyon Road, Sylmar CA
○ **Location:** HS-2 & HS-4 @ 0-10' 50/50 blend

ALLAN E. SEWARD ENGINEERING GEOLOGY, INC.

Valencia, California

Material Description

Brown, silty SAND (SM)

Remarks:

Mixture of on-site soils

Checked by: K. Callahan
Title: Geotechnical Engineer

Figure B2

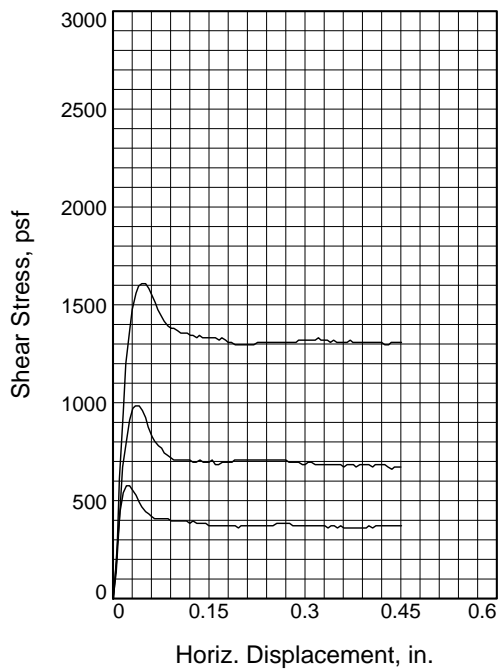
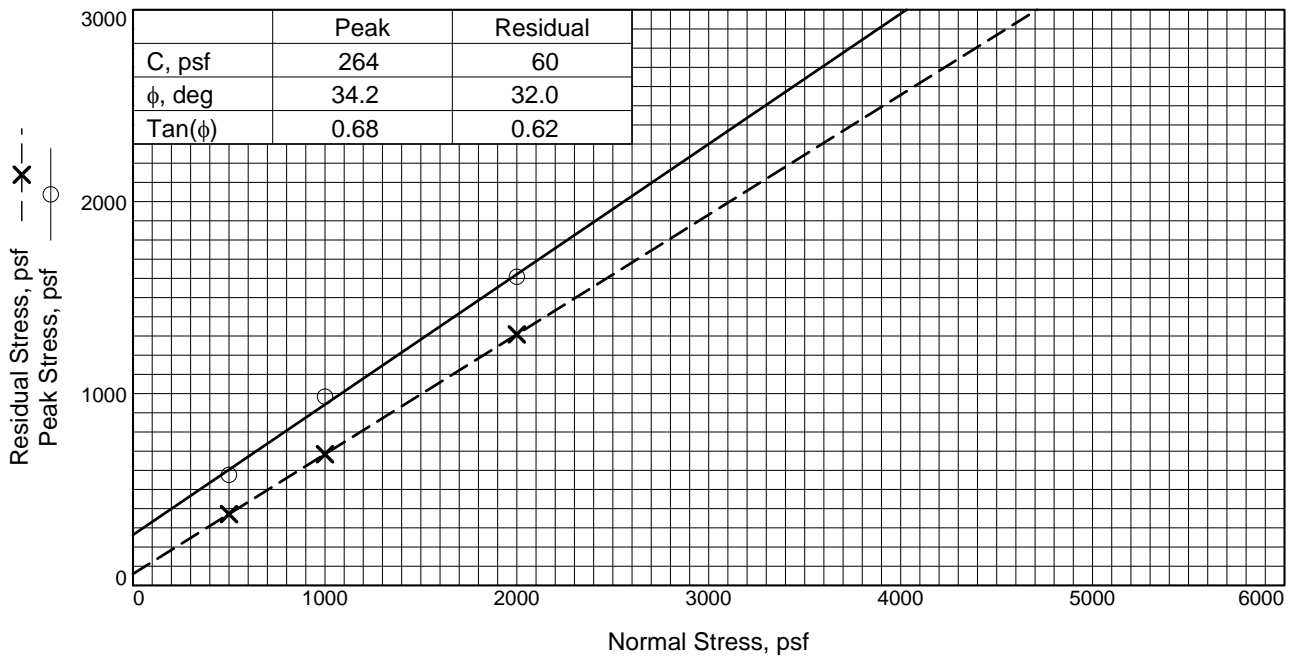

Sample No.	1	2	3	
Initial	Water Content, %	7.7	7.8	7.7
	Dry Density, pcf	122.0	121.7	121.8
	Saturation, %	56.9	57.6	57.0
	Void Ratio	0.3565	0.3593	0.3582
	Diameter, in.	2.42	2.42	2.42
	Height, in.	1.00	1.00	1.00
At Test	Water Content, %	13.3	13.2	13.1
	Dry Density, pcf	122.3	122.5	122.7
	Saturation, %	100.0	100.0	100.0
	Void Ratio	0.3526	0.3506	0.3483
	Diameter, in.	2.42	2.42	2.42
	Height, in.	1.00	0.99	0.99
Normal Stress, psf	500	1000	2000	
Peak Stress, psf	576	984	1608	
Displacement, in.	0.02	0.04	0.05	
Residual Stress, psf	372	684	1308	
Displacement, in.	0.45	0.42	0.45	
Strain rate, in./min.	0.010	0.010	0.010	

Sample Type: Remold
Description: Brown, silty SAND (SM)
Assumed Specific Gravity= 2.65
Remarks: Representative fill mixture
 Remolded to about 90% of MDD
 % Fines = 22.8

Client: Union Rescue Mission
Project: URM Hope Gardens - Sequoia Building
 12249 Lopez Canyon Road, Sylmar CA
Location: HS-2 & HS-4 @ 0-10' 50/50 blend

Proj. No.: 20-2563 **Date Sampled:** 8/27/20

DIRECT SHEAR TEST REPORT
 ALLAN E. SEWARD ENGINEERING GEOLOGY, INC.
 Valencia, California

Figure B3.1

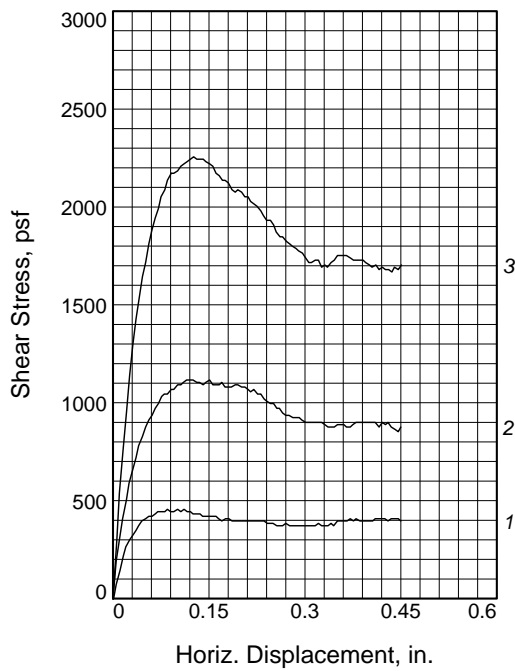
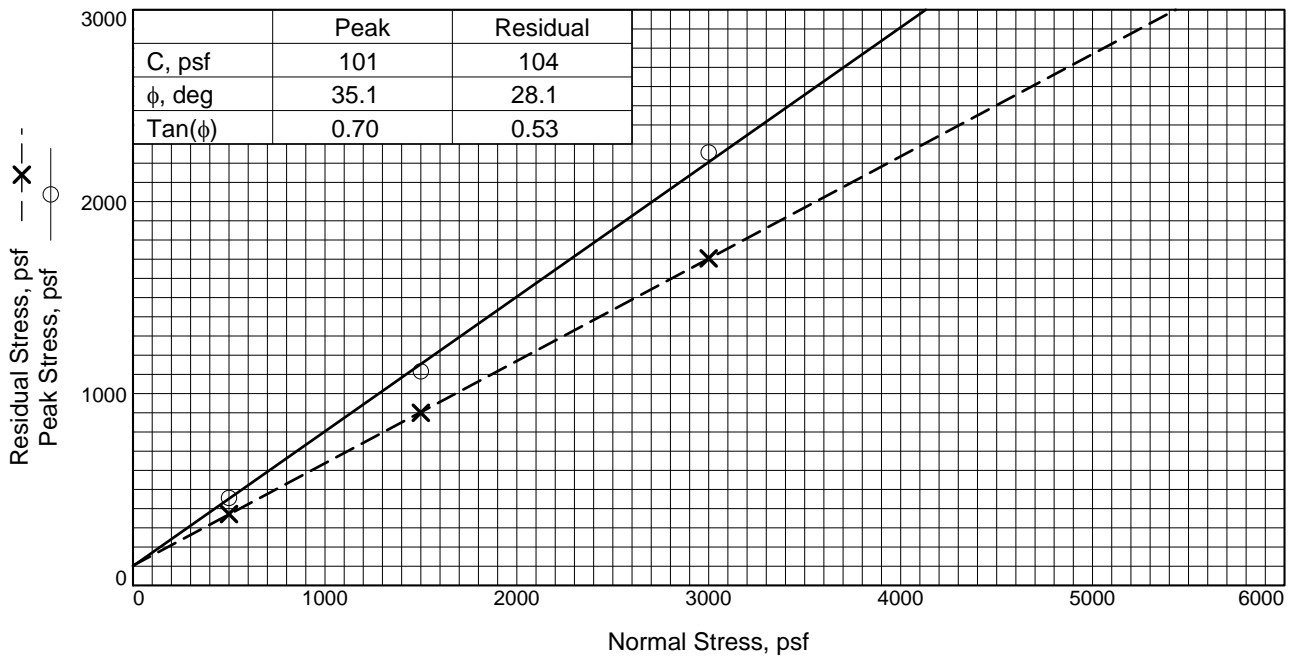

Sample No.	1	2	3	
Initial	Water Content, %	3.8	3.7	4.9
	Dry Density, pcf	111.8	111.9	113.4
	Saturation, %	20.8	20.5	28.1
	Void Ratio	0.4800	0.4780	0.4588
	Diameter, in.	2.42	2.42	2.42
	Height, in.	1.00	1.00	1.00
At Test	Water Content, %	17.8	17.5	16.2
	Dry Density, pcf	112.4	113.0	115.8
	Saturation, %	100.0	100.0	100.0
	Void Ratio	0.4722	0.4636	0.4283
	Diameter, in.	2.42	2.42	2.42
	Height, in.	0.99	0.99	0.98
Normal Stress, psf	500	1500	3000	
Peak Stress, psf	456	1116	2256	
Displacement, in.	0.09	0.12	0.13	
Residual Stress, psf	372	900	1704	
Displacement, in.	0.30	0.43	0.45	
Strain rate, in./min.	0.010	0.010	0.010	

Sample Type: Modified California Drive
Description: Poorly graded SAND with silt and gravel

Assumed Specific Gravity= 2.65

Remarks: Alluvium (Qal)

% Fines = 9.1

Client: Union Rescue Mission

Project: URM Hope Gardens - Sequoia Building
 12249 Lopez Canyon Road, Sylmar CA

Source of Sample: HS-1 **Depth:** 10'

Proj. No.: 20-2563

Date Sampled: 8/27/20

DIRECT SHEAR TEST REPORT
 ALLAN E. SEWARD ENGINEERING GEOLOGY, INC.
 Valencia, California

Figure B3.2

SWELL/CONSOLIDATION TEST REPORT

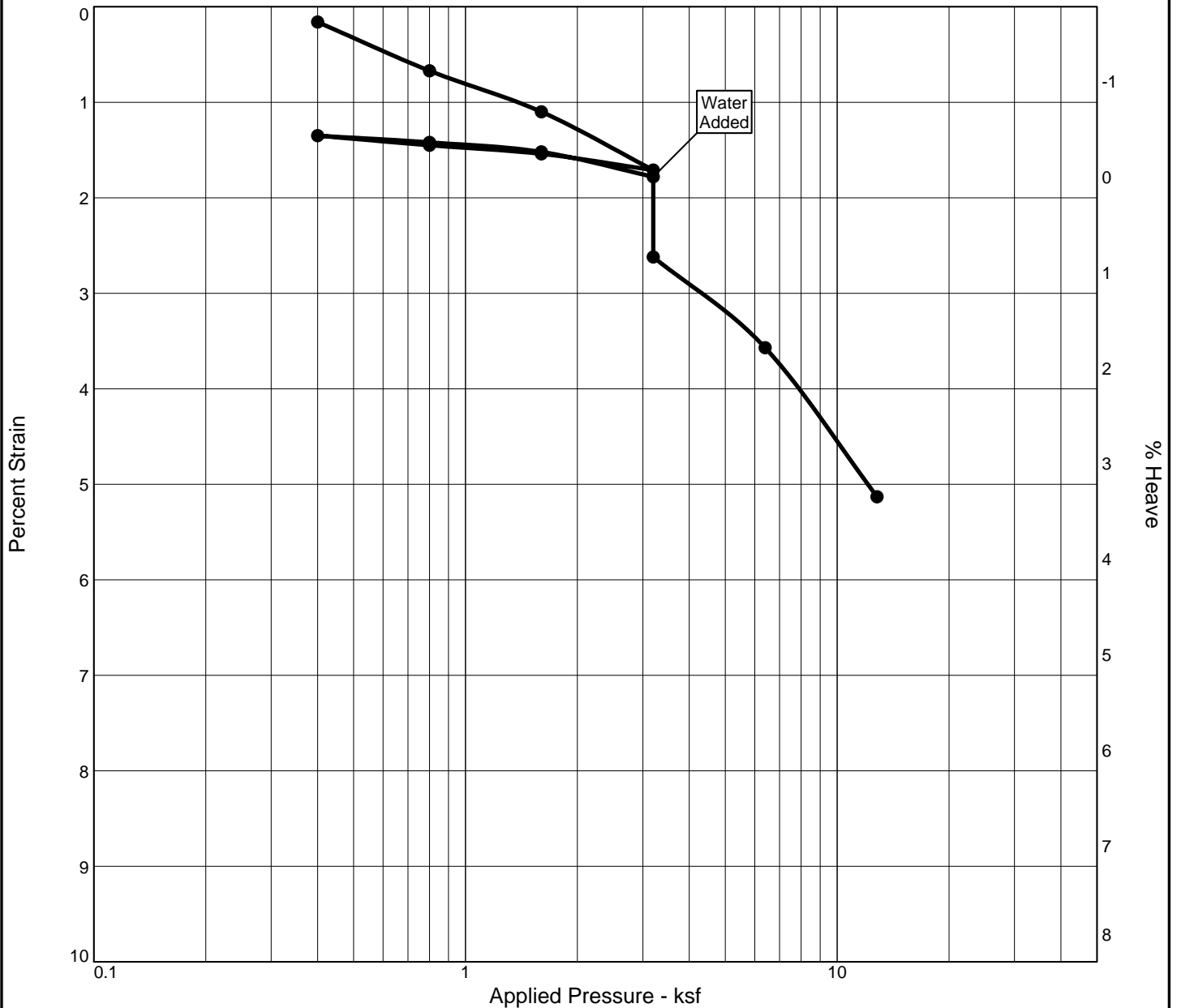

MATERIAL DESCRIPTION										USCS	AASHTO		
Poorly graded SAND with silt and gravel										SP-SM			
LL	PI	Sp. Gr.	Overburden (ksf)	Dry Dens. (pcf)		Moisture		Saturation		Void Ratio		P _c (ksf)	C _c
				Init.	Final	Init.	Final	Init.	Final	Init.	Final		
		2.65	3.2	108.5	114.3	3.5 %	14.9	17.5 %	88.4 %	0.525	0.447	6.5	0.08
Preparation Process: Tested directly in a ring from a ring lined sampler										D2435 Method	C _s	Swell Press. (ksf)	Heave %
Condition of Test: Inundated with distilled water at psf										D4546	0.01		-0.9
Project No. 20-2563 Client: Union Rescue Mission Project: URM Hope Gardens - Sequoia Building 12249 Lopez Canyon Road, Sylmar CA Source of Sample: HS-1 Depth: 10' ALLAN E. SEWARD ENGINEERING GEOLOGY, INC. Valencia, California										Remarks: Alluvium (Qal) % Fines = 9.1 Checked By: K. Callahan Title: Geotechnical Engineer			
										Figure B4.1			

SWELL/CONSOLIDATION TEST REPORT

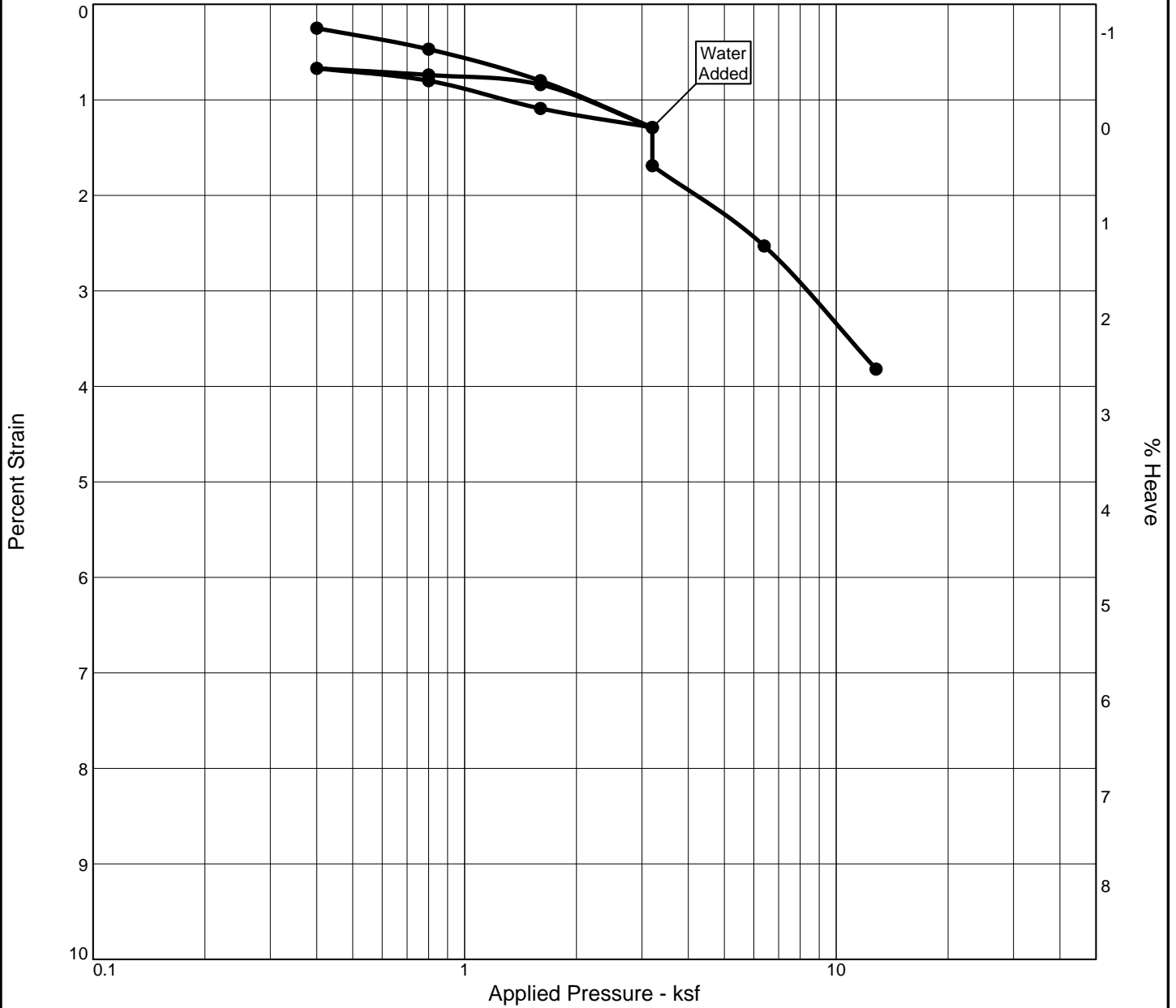

MATERIAL DESCRIPTION	USCS	AASHTO
Well-graded SAND with silt	SW-SM	

LL	PI	Sp. Gr.	Overburden (ksf)	Dry Dens. (pcf)		Moisture		Saturation		Void Ratio		P _c (ksf)	C _c
				Init.	Final	Init.	Final	Init.	Final	Init.	Final		
		2.65	3.2	109.0	113.3	4.1 %	15.5	21.1 %	89.3 %	0.518	0.460	6.6	0.07

Preparation Process: Tested directly in a ring from a ring lined sampler	D2435 Method	C _s	Swell Press. (ksf)	Heave %
Condition of Test: Inundated with distilled water at p _s	D4546	0.01		-0.4

Project No. 20-2563 Client: Union Rescue Mission Project: URM Hope Gardens - Sequoia Building 12249 Lopez Canyon Road, Sylmar CA Source of Sample: HS-5 Depth: 13' ALLAN E. SEWARD ENGINEERING GEOLOGY, INC. Valencia, California	Remarks: Alluvium (Qal) % Fines = 7.2 <hr/> Checked By: K. Callahan Title: Geotechnical Engineer <p style="text-align: right;">Figure B4.2</p>
---	---

Appendix C

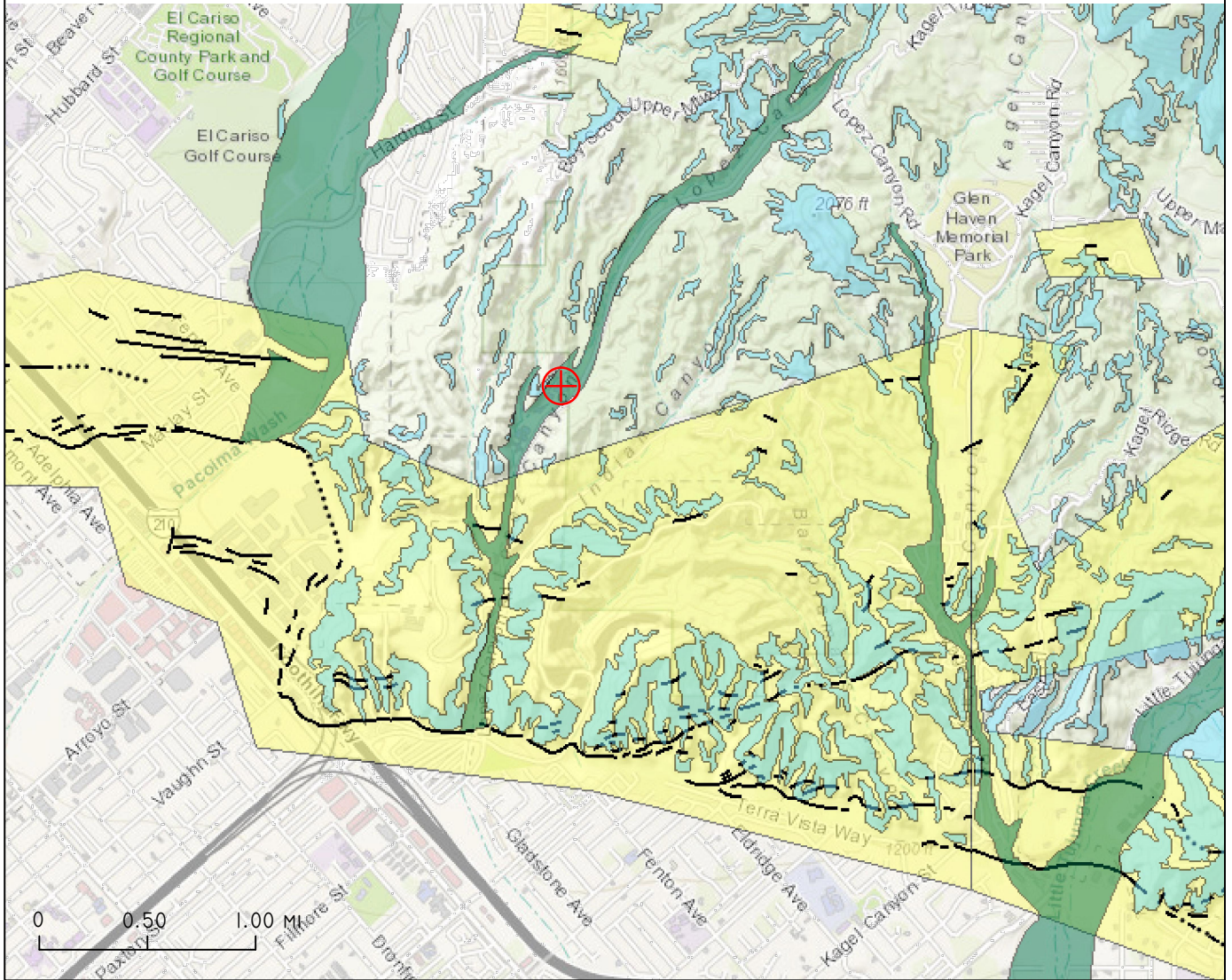

LEGEND

Colors may vary due to transparency and overlapping data.

Fault Traces

- Accurately Located
- - - Approximately Located
- ? - - - Approximately Located, Queried
- Inferred
- ? - Inferred, Queried
- Concealed
- ?..... Concealed, Queried
- - - Aerial Photo Lineament

Fault Zone



Liquefaction Zone



Landslide Zone



APPROXIMATE LOCATION OF SUBJECT SITE



SOURCE; CALIFORNIA GEOLOGIC SURVEY
EARTHQUAKE ZONES WEB APPLICATION



 <p>ALLAN E. SEWARD ENGINEERING GEOLOGY, INC. Geological And Geotechnical Consultants</p>		
<p>EARTHQUAKE ZONES OF REQUIRED INVESTIGATION</p>		
<p>Job No.: 20-2653-5</p>		
<table border="1" style="width: 100%; border-collapse: collapse;"> <tr> <td style="width: 50%;">DATE: 10/14/20</td> <td style="width: 50%;">FIGURE: C1</td> </tr> </table>	DATE: 10/14/20	FIGURE: C1
DATE: 10/14/20	FIGURE: C1	

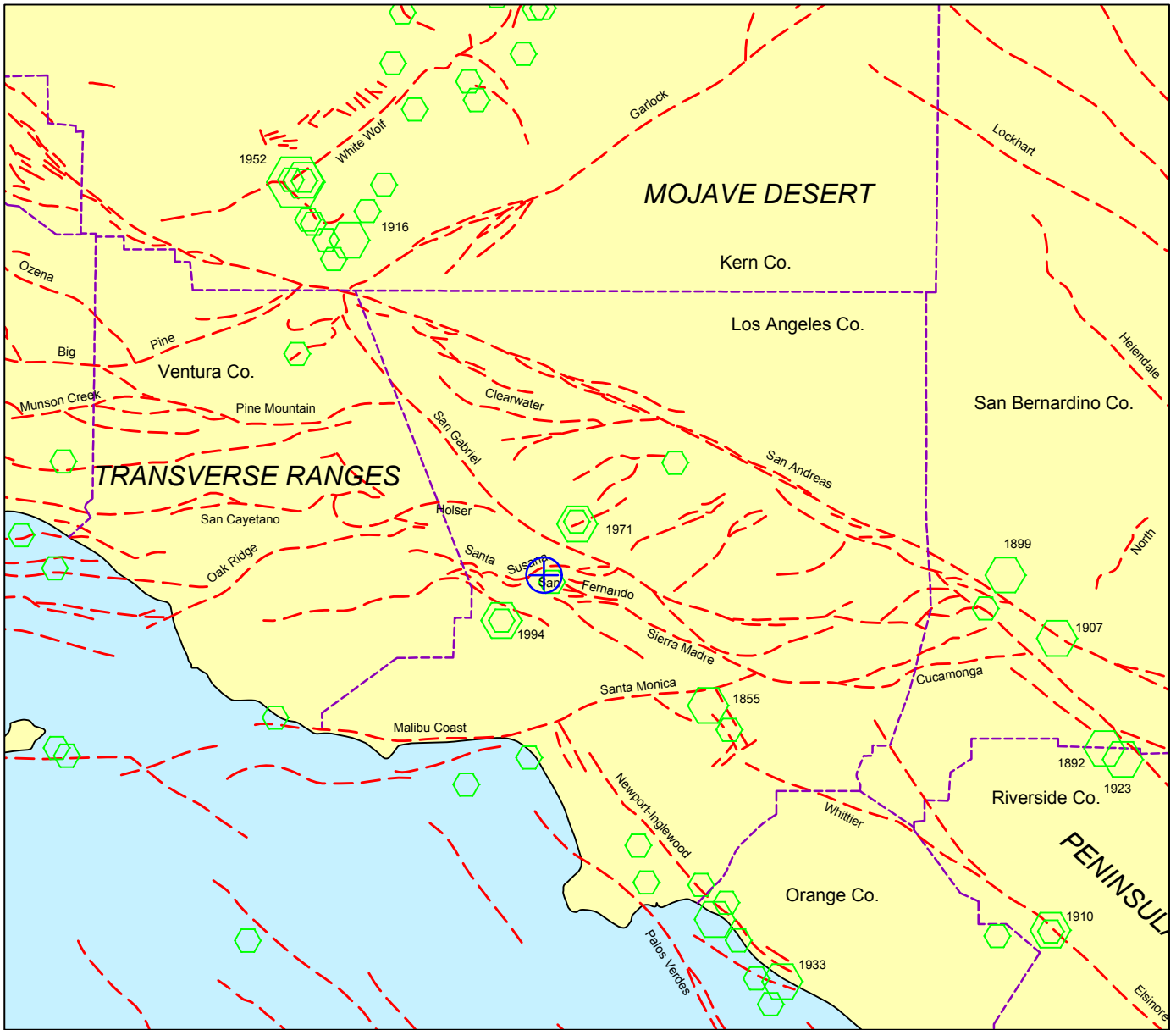

EXPLANATION

APPROXIMATE LOCATION OF MAJOR KNOWN FAULTS



EARTHQUAKE EPICENTERS

LOCATION	MAGNITUDE
	5.0 - 5.9
	6.0 - 6.9
	7.0 - 7.9



APPROXIMATE LOCATION OF SUBJECT SITE



COMPILED AND MODIFIED FROM: JENNINGS (1994), REAL ET AL. (1978), YERKES (1985), ZIONY AND JONES (1989), AND SHAKAL ET AL. (1994)

	ALLAN E. SEWARD ENGINEERING GEOLOGY, INC. Geological And Geotechnical Consultants
	FAULT AND EARTHQUAKE EPICENTER LOCATION MAP
JOB No.: 20-2653-5	
DATE: 10/14/20	FIGURE: C2



URM Hope Gardens - Sequoia Building

Latitude, Longitude: 34.30268, -118.3969



Date	9/4/2020, 12:59:25 PM
Design Code Reference Document	ASCE7-16
Risk Category	II
Site Class	D - Default (See Section 11.4.3)

Type	Value	Description
S _S	2.448	MCE _R ground motion. (for 0.2 second period)
S ₁	0.788	MCE _R ground motion. (for 1.0s period)
S _{MS}	2.937	Site-modified spectral acceleration value
S _{M1}	null -See Section 11.4.8	Site-modified spectral acceleration value
S _{DS}	1.958	Numeric seismic design value at 0.2 second SA
S _{D1}	null -See Section 11.4.8	Numeric seismic design value at 1.0 second SA

Type	Value	Description
------	-------	-------------

Type	Value	Description
SDC	null -See Section 11.4.8	Seismic design category
F _a	1.2	Site amplification factor at 0.2 second
F _v	null -See Section 11.4.8	Site amplification factor at 1.0 second
PGA	0.999	MCE _G peak ground acceleration
F _{PGA}	1.2	Site amplification factor at PGA
PGA _M	1.199	Site modified peak ground acceleration
T _L	8	Long-period transition period in seconds
SsRT	2.578	Probabilistic risk-targeted ground motion. (0.2 second)
SsUH	2.848	Factored uniform-hazard (2% probability of exceedance in 50 years) spectral acceleration
SsD	2.448	Factored deterministic acceleration value. (0.2 second)
S1RT	0.927	Probabilistic risk-targeted ground motion. (1.0 second)
S1UH	1.039	Factored uniform-hazard (2% probability of exceedance in 50 years) spectral acceleration.
S1D	0.788	Factored deterministic acceleration value. (1.0 second)
PGAd	0.999	Factored deterministic acceleration value. (Peak Ground Acceleration)
C _{RS}	0.905	Mapped value of the risk coefficient at short periods
C _{R1}	0.892	Mapped value of the risk coefficient at a period of 1 s

APPENDIX C

DEAGGREGATION OUTPUT AND PARAMETERS

*** Deaggregation of Seismic Hazard at One Period of Spectral Acceleration ***

*** Data from Dynamic: Conterminous U.S. 2014 (update) (v4.2.0) ****

PSHA Deaggregation. %contributions.

site: URM Hope Gardens, Sequoia Building

longitude: 118.397°W

latitude: 34.303°E

imt: Peak ground acceleration

vs30 = 360 m/s (C/D boundary)

return period: 2475 yrs.

This deaggregation corresponds to: Total

Summary statistics for PSHA PGA deaggregation, r=distance, ϵ =epsilon:

Deaggregation targets:

Return period: 2475 yrs

Exceedance rate: 0.0004040404 yr⁻¹

PGA ground motion: 1.1855866 g

Mean (over all sources):

m: 6.75

r: 4.52 km

ϵ_0 : 1.53 σ

Discretization:

r: min = 0.0, max = 1000.0, Δ = 20.0 km

m: min = 4.4, max = 9.4, Δ = 0.2

ϵ : min = -3.0, max = 3.0, Δ = 0.5 σ

Recovered targets:

Return period: 2921.1313 yrs

Exceedance rate: 0.00034233313 yr⁻¹

Mode (largest m-r bin):

m: 6.3

r: 3.98 km

ϵ_0 : 1.67 σ

Contribution: 17.78 %

Epsilon keys:

ϵ_0 : [- ∞ .. -2.5)

ϵ_1 : [-2.5 .. -2.0)

ϵ_2 : [-2.0 .. -1.5)

ϵ_3 : [-1.5 .. -1.0)

ϵ_4 : [-1.0 .. -0.5)

ϵ_5 : [-0.5 .. 0.0)

ϵ_6 : [0.0 .. 0.5)

ϵ_7 : [0.5 .. 1.0)

ϵ_8 : [1.0 .. 1.5)

ϵ_9 : [1.5 .. 2.0)

ϵ_{10} : [2.0 .. 2.5)

ϵ_{11} : [2.5 .. + ∞]

Totals:

Binned: 100 %

Residual: 0 %

Trace: 0.03 %

Mode (largest m-r- ϵ_0 bin):

m: 6.27

r: 3.48 km

ϵ_0 : 1.68 σ

Contribution: 11.73 %

APPENDIX C

Closest Distance, rRup (km)	Mag. (Mw)	ALL ϵ	$\epsilon=[2.5,\infty)$	$\epsilon=[2,2.5)$	$\epsilon=[1.5,2)$	$\epsilon=[1,1.5)$	$\epsilon=[0.5,1)$	$\epsilon=(-\infty,0.5)$	$\epsilon=[-0.5,\infty)$	$\epsilon=[-1,-0.5)$	$\epsilon=[-1.5,-1)$	$\epsilon=[-2,-1.5)$	$\epsilon=[-2.5,-2)$	$\epsilon=(-\infty,-2.5)$
50	8.1	0.000	0.000	0.000	0.000	0.000	0.000	0.000	0.000	0.000	0.000	0.000	0.000	0.000
30	6.3	0.004	0.004	0.000	0.000	0.000	0.000	0.000	0.000	0.000	0.000	0.000	0.000	0.000
30	6.5	0.019	0.019	0.000	0.000	0.000	0.000	0.000	0.000	0.000	0.000	0.000	0.000	0.000
30	6.7	0.013	0.001	0.012	0.000	0.000	0.000	0.000	0.000	0.000	0.000	0.000	0.000	0.000
30	6.9	0.098	0.030	0.068	0.000	0.000	0.000	0.000	0.000	0.000	0.000	0.000	0.000	0.000
30	7.1	0.071	0.013	0.058	0.000	0.000	0.000	0.000	0.000	0.000	0.000	0.000	0.000	0.000
30	7.3	0.100	0.028	0.072	0.000	0.000	0.000	0.000	0.000	0.000	0.000	0.000	0.000	0.000
30	7.5	0.081	0.000	0.051	0.030	0.000	0.000	0.000	0.000	0.000	0.000	0.000	0.000	0.000
30	7.7	0.113	0.075	0.038	0.000	0.000	0.000	0.000	0.000	0.000	0.000	0.000	0.000	0.000
30	7.9	0.116	0.042	0.074	0.000	0.000	0.000	0.000	0.000	0.000	0.000	0.000	0.000	0.000
30	8.1	0.200	0.001	0.200	0.000	0.000	0.000	0.000	0.000	0.000	0.000	0.000	0.000	0.000
30	8.3	0.172	0.001	0.171	0.000	0.000	0.000	0.000	0.000	0.000	0.000	0.000	0.000	0.000
10	5.1	3.075	2.999	0.075	0.000	0.000	0.000	0.000	0.000	0.000	0.000	0.000	0.000	0.000
10	5.3	3.582	1.431	2.104	0.047	0.000	0.000	0.000	0.000	0.000	0.000	0.000	0.000	0.000
10	5.5	4.266	0.700	1.922	1.449	0.196	0.000	0.000	0.000	0.000	0.000	0.000	0.000	0.000
10	5.7	3.666	1.123	1.213	1.029	0.301	0.000	0.000	0.000	0.000	0.000	0.000	0.000	0.000
10	5.9	2.956	1.593	0.659	0.380	0.324	0.000	0.000	0.000	0.000	0.000	0.000	0.000	0.000
10	6.1	2.960	1.029	0.819	0.919	0.192	0.000	0.000	0.000	0.000	0.000	0.000	0.000	0.000
10	6.3	17.783	4.407	11.727	1.510	0.140	0.000	0.000	0.000	0.000	0.000	0.000	0.000	0.000
10	6.5	5.992	1.902	3.227	0.741	0.122	0.000	0.000	0.000	0.000	0.000	0.000	0.000	0.000
10	6.7	7.076	4.605	2.077	0.339	0.055	0.000	0.000	0.000	0.000	0.000	0.000	0.000	0.000
10	6.9	8.040	0.140	5.348	2.037	0.473	0.043	0.000	0.000	0.000	0.000	0.000	0.000	0.000
10	7.1	4.243	0.999	2.396	0.612	0.201	0.035	0.000	0.000	0.000	0.000	0.000	0.000	0.000
10	7.3	5.867	0.739	3.409	1.418	0.266	0.035	0.000	0.000	0.000	0.000	0.000	0.000	0.000
10	7.5	12.950	3.366	7.006	2.048	0.502	0.027	0.000	0.000	0.000	0.000	0.000	0.000	0.000
10	7.7	11.749	3.700	5.595	2.045	0.387	0.023	0.000	0.000	0.000	0.000	0.000	0.000	0.000

APPENDIX C

Principal Sources (faults, subduction, random seismicity having > 3% contribution)

UC33brAvg_FM32: Percent Contributed: 42.57 Distance (km): 3.8980641 Magnitude: 7.043712 Epsilon (mean values): 1.4280506	Mission Hills 2011 [0]: Percent Contributed: 3.25 Distance (km): 4.285107 Magnitude: 7.0147362 Epsilon (mean values): 1.363737 Azimuth: 209.70792 Latitude: 34.270223 Longitude: -118.41931	Sierra Madre (San Fernando) [1]: Percent Contributed: 8.8 Distance (km): 1.4151704 Magnitude: 7.5200125 Epsilon (mean values): 1.068497 Azimuth: 237.06288 Latitude: 34.299946 Longitude: -118.40201	Northridge [4]: Percent Contributed: 2.31 Distance (km): 8.349439 Magnitude: 7.1834007 Epsilon (mean values): 1.4671992 Azimuth: 97.735957 Latitude: 34.302199 Longitude: -118.39262	PointSourceFinite: -118.397, 34.307: Percent Contributed: 4.9 Distance (km): 5.0331695 Magnitude: 5.594227 Epsilon (mean values): 1.8395077 Azimuth: 0 Latitude: 34.307177 Longitude: -118.3969
Sierra Madre (San Fernando) [1]: Percent Contributed: 11.22 Distance (km): 1.4151704 Magnitude: 7.4058812 Epsilon (mean values): 1.1003964 Azimuth: 237.06288 Latitude: 34.299946 Longitude: -118.40201	Verdugo [3]: Percent Contributed: 2.68 Distance (km): 4.1927229 Magnitude: 7.5238336 Epsilon (mean values): 1.1574603 Azimuth: 203.83756 Latitude: 34.269 Longitude: -118.41491	Santa Susana East (connector) [1]: Percent Contributed: 8.57 Distance (km): 2.8765883 Magnitude: 6.8212071 Epsilon (mean values): 1.4740253 Azimuth: 240.16784 Latitude: 34.292074 Longitude: -118.41928	San Gabriel [1]: Percent Contributed: 1.01 Distance (km): 6.9866555 Magnitude: 7.3713469 Epsilon (mean values): 1.7889143 Azimuth: 19.782311 Latitude: 34.360478 Longitude: -118.37172	UC33brAvg_FM32 (opt): Percent Contributed: 11.5 Distance (km): 5.7185602 Magnitude: 5.6779528 Epsilon (mean values): 1.9201124
Santa Susana East (connector) [1]: Percent Contributed: 10.52 Distance (km): 2.8765883 Magnitude: 6.5727063 Epsilon (mean values): 1.5608381 Azimuth: 240.16784 Latitude: 34.292074 Longitude: -118.41928	Northridge [4]: Percent Contributed: 1.75 Distance (km): 8.349439 Magnitude: 7.1757588 Epsilon (mean values): 1.4737678 Azimuth: 97.735957 Latitude: 34.302199 Longitude: -118.39262	Mission Hills 2011 [0]: Percent Contributed: 7.52 Distance (km): 4.285107 Magnitude: 6.4773786 Epsilon (mean values): 1.5034249 Azimuth: 209.70792 Latitude: 34.270223 Longitude: -118.41931	UC33brAvg_FM31 (opt): Percent Contributed: 11.61 Distance (km): 5.7498295 Magnitude: 5.6870293 Epsilon (mean values): 1.9212908	PointSourceFinite: -118.397, 34.307: Percent Contributed: 4.89 Distance (km): 5.0299996 Magnitude: 5.5891996 Epsilon (mean values): 1.8413904 Azimuth: 0 Latitude: 34.307177 Longitude: -118.3969
Santa Susana alt 2 [0]: Percent Contributed: 9.89 Distance (km): 3.6422895 Magnitude: 6.8327147 Epsilon (mean values): 1.5848029 Azimuth: 23.962876 Latitude: 34.331316 Longitude: -118.38149	UC33brAvg_FM31: Percent Contributed: 34.33 Distance (km): 4.4829673 Magnitude: 7.0917535 Epsilon (mean values): 1.4039602	Verdugo [3]: Percent Contributed: 2.98 Distance (km): 4.1927229 Magnitude: 7.5449507 Epsilon (mean values): 1.1656069 Azimuth: 203.83756 Latitude: 34.269 Longitude: -118.41491	PointSourceFinite: -118.397, 34.307: Percent Contributed: 4.9 Distance (km): 5.0331695 Magnitude: 5.594227 Epsilon (mean values): 1.8395077 Azimuth: 0 Latitude: 34.307177 Longitude: -118.3969	PointSourceFinite: -118.397, 34.307: Percent Contributed: 4.89 Distance (km): 5.0299996 Magnitude: 5.5891996 Epsilon (mean values): 1.8413904 Azimuth: 0 Latitude: 34.307177 Longitude: -118.3969

HAZARD CONTRIBUTIONS

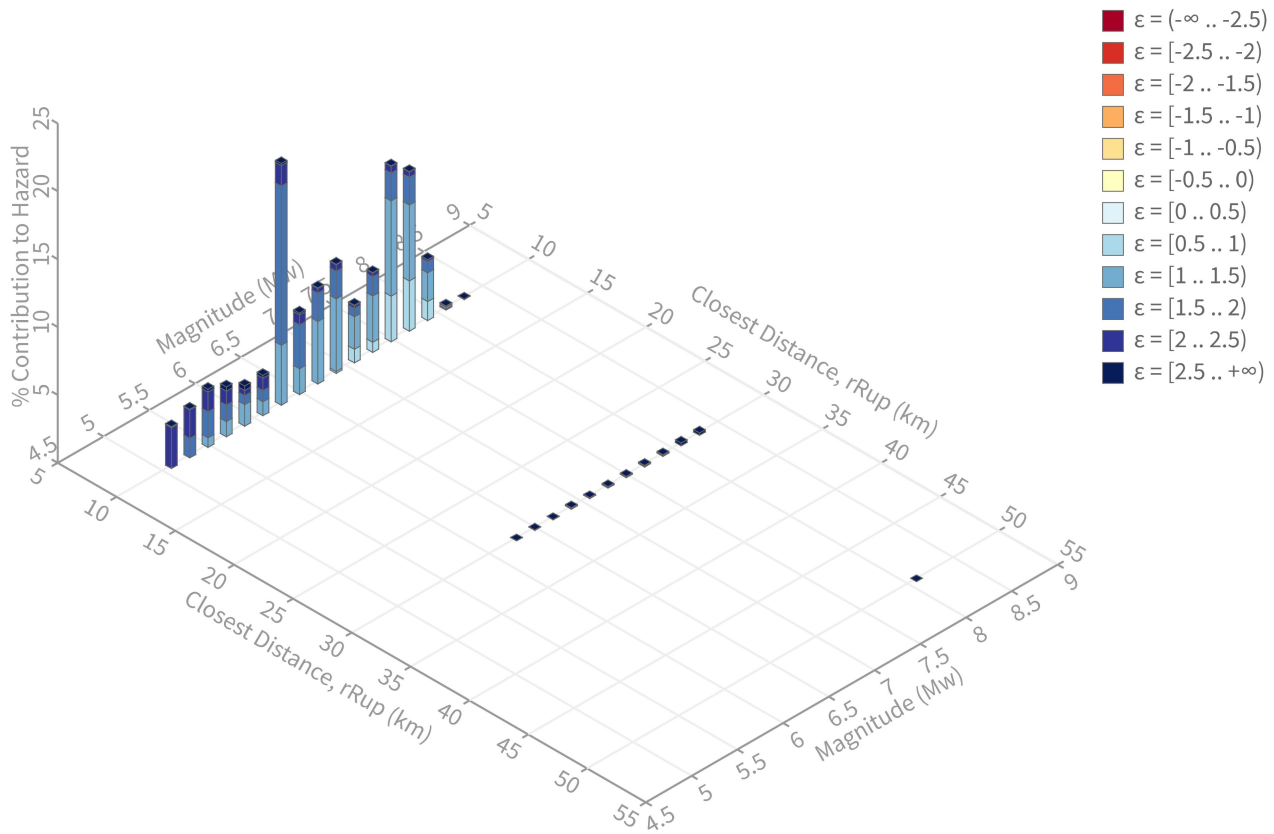

ALLAN E. SEWARD
ENGINEERING GEOLOGY, INC.
 Geological and Geotechnical Consultants

MAGNITUDE-DISTANCE CONTRIBUTIONS TO HAZARD

Job No.: 20-2653-5

DATE: 10/14/20

FIGURE: C3

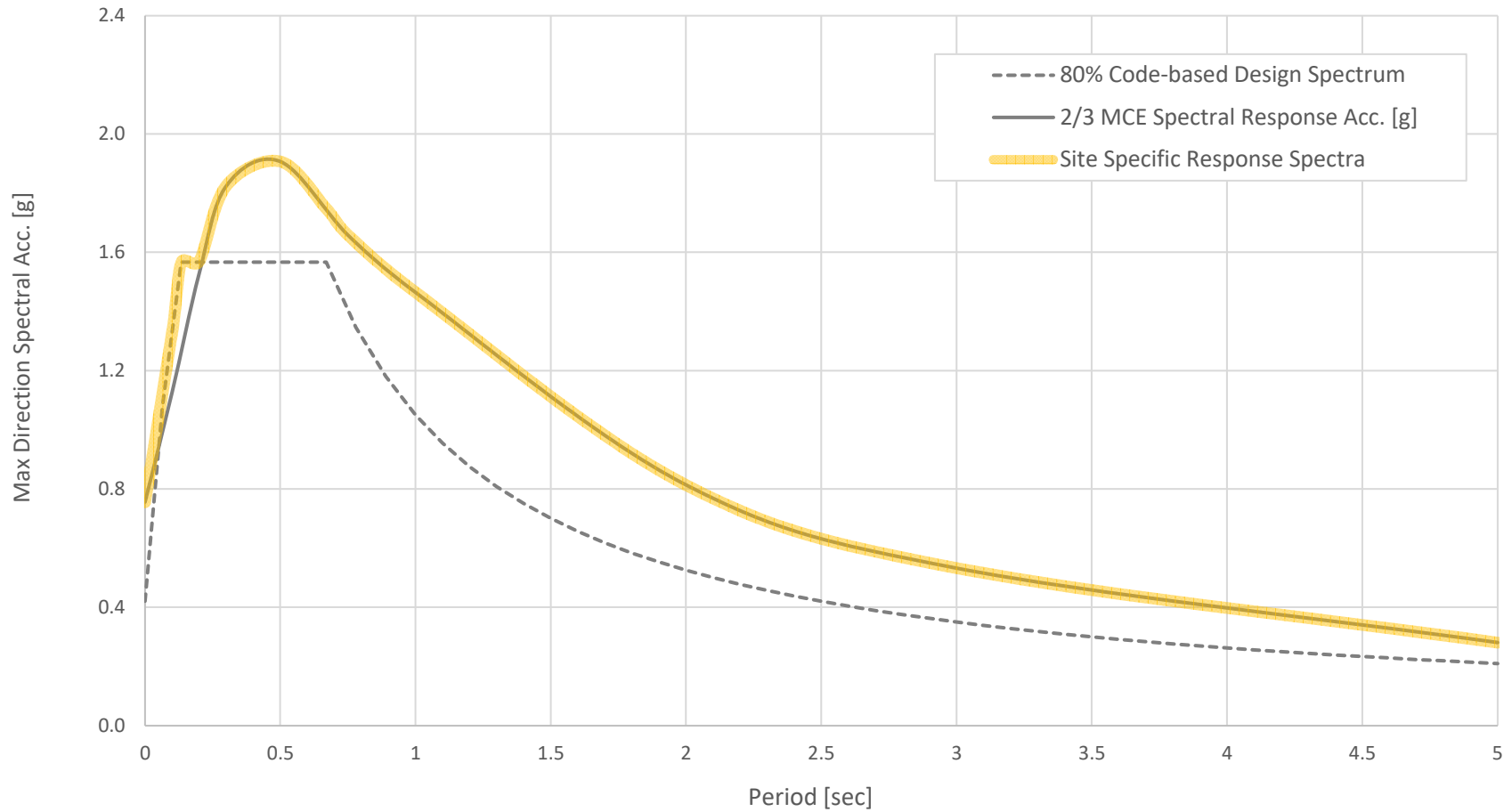

Site Coordinates		Site Class	Risk Category	SDC	S_{MS}	S_{M1}	S_{DS}	S_{D1}	PGA
Lat	Long								
34.30268	118.3969	D	I, II or III	D	2.575	2.441	1.717	1.627	0.76

Design Reference: 2019 CBC and ASCE 7-16

ALLAN E. SEWARD
ENGINEERING GEOLOGY, INC.
 Geological and Geotechnical Consultants

Site-Specific Response Spectra and Seismic Design Parameters

Client:	Union Rescue Mission	Job No.:	20-2653
Project:	URM Hope Gardens - Sequoia Building	Date:	10/14/20
	12279 Lopez Canyon Rd., Sylmar	Figure:	C4

Code-Based Ground Motions

Design Reference: ASCE 7-16, Sections 11.4 and 21.3

Job No.: 20-2653

Parameter	Value	Description
S_S	2.448	MCE_R ground motion (0.2 sec)
S_1	0.788	MCE_R ground motion (1.0 sec)
F_a	1.2	Site amplification factor (0.2 sec)
F_v	2.5	Site amplification factor (1.0 sec)
S_{MS}	2.9376	Site-modified spectral acc. (0.2 sec)
S_{M1}	1.970	Site-modified spectral acc. (1.0 sec)
S_{DS}	1.958	Design spectral acc. value (0.2 sec)
S_{D1}	1.313	Design spectral acc. value (1.0 sec)
PGA	0.999	MCE_G peak ground acceleration
F_{PGA}	1.1	Site amplification factor at PGA
PGA_M	1.10	Site-modified peak ground acc. (Eq. 11.8-1)

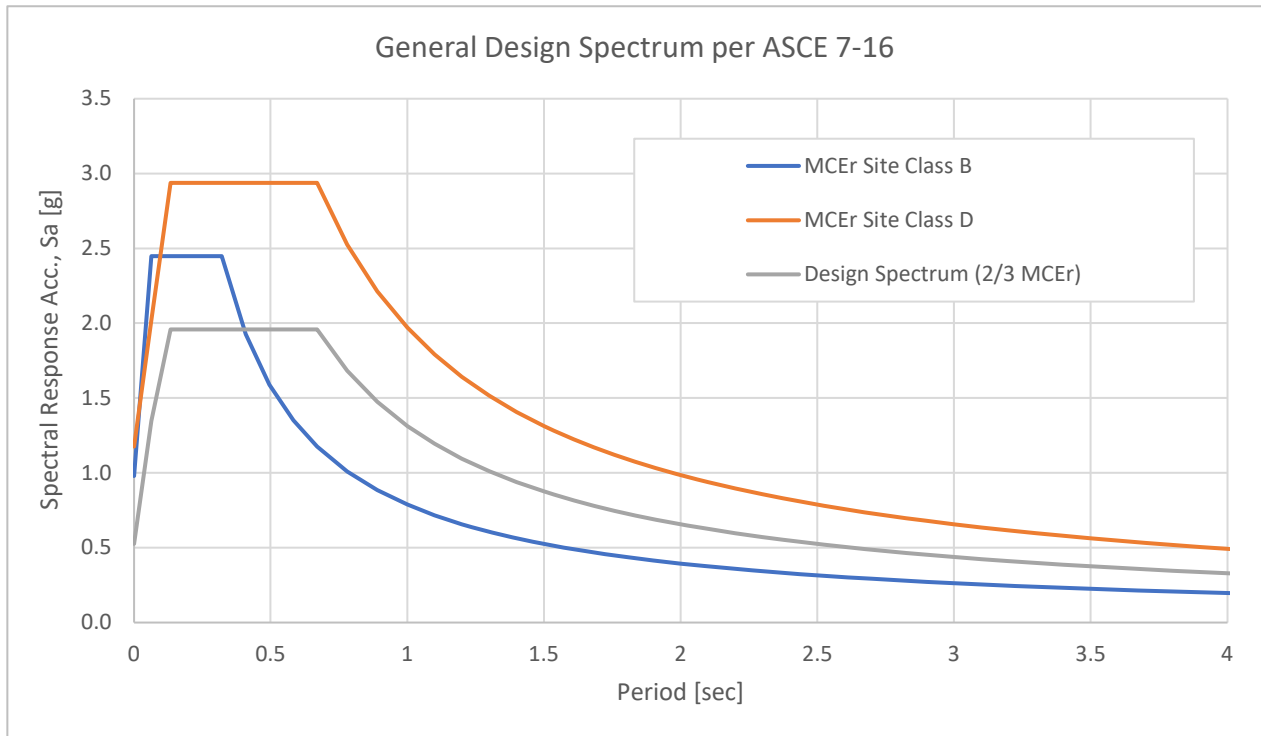

Probabilistic MCE_R Ground Motions

Design Reference: ASCE 7-16, Section 21.2.1 Method 2

Union Rescue Mission

Job No.: 20-2653

Period [sec]	UHGM [g]	RTGM [g]	Max Direction Scale Factor	Max Dir RTGM [g]
0	1.072	1.031	1.1	1.134
0.1	1.763	1.720	1.1	1.892
0.2	2.267	2.221	1.1	2.443
0.3	2.601	2.504	1.125	2.817
0.5	2.614	2.435	1.175	2.861
0.75	2.220	2.011	1.2375	2.489
1	1.870	1.691	1.3	2.198
2	1.013	0.904	1.35	1.220
3	0.643	0.571	1.4	0.799
5	0.315	0.281	1.5	0.422

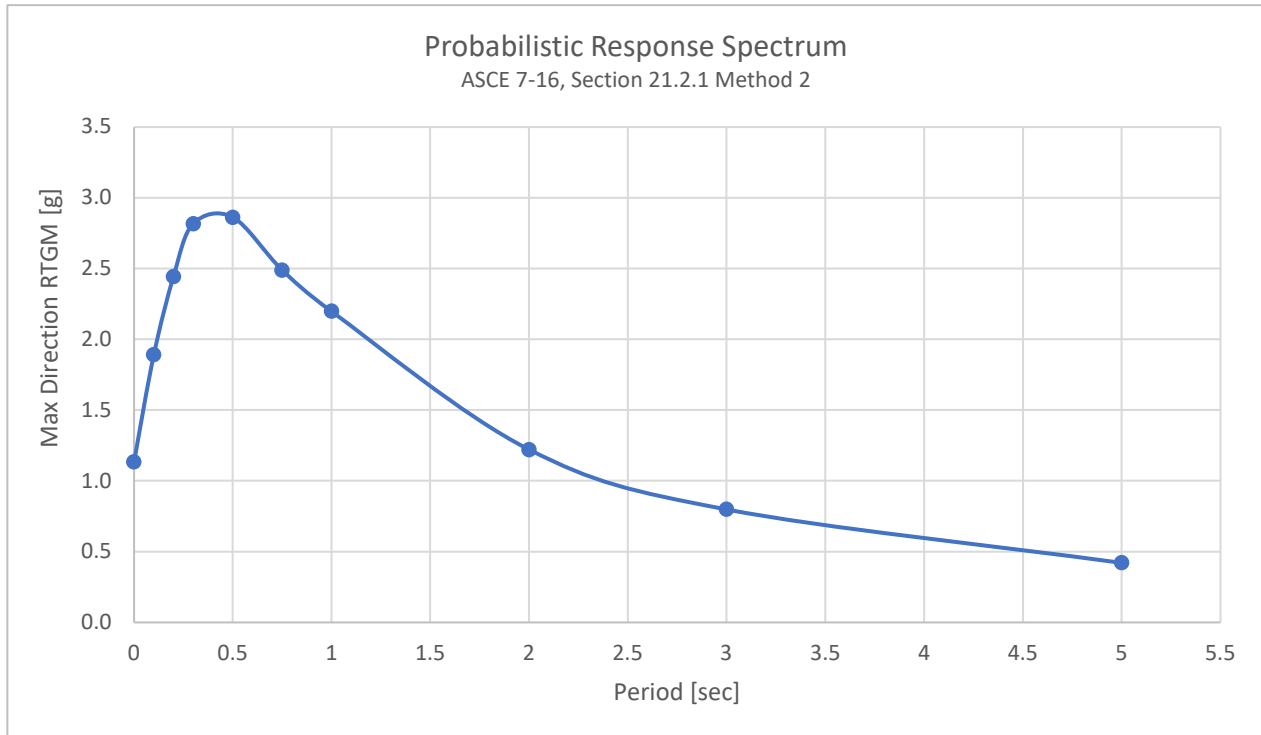

Deterministic MCE_R Ground Motions

Design Reference: ASCE 7-16, Section 21.2.2

Union Rescue Mission

Job No.: 20-2653

Period [sec]	84th Percentile Spectral Acc. [g]	Max Direction Scale Factor	Max Deterministic Spectral Acc. [g]
0	1.044	1.1	1.148
0.1	1.537	1.1	1.691
0.2	2.084	1.1	2.292
0.3	2.433	1.125	2.737
0.5	2.477	1.175	2.910
0.75	2.084	1.2375	2.579
1	1.777	1.3	2.310
2	0.942	1.35	1.272
3	0.630	1.4	0.882
5	0.301	1.5	0.452

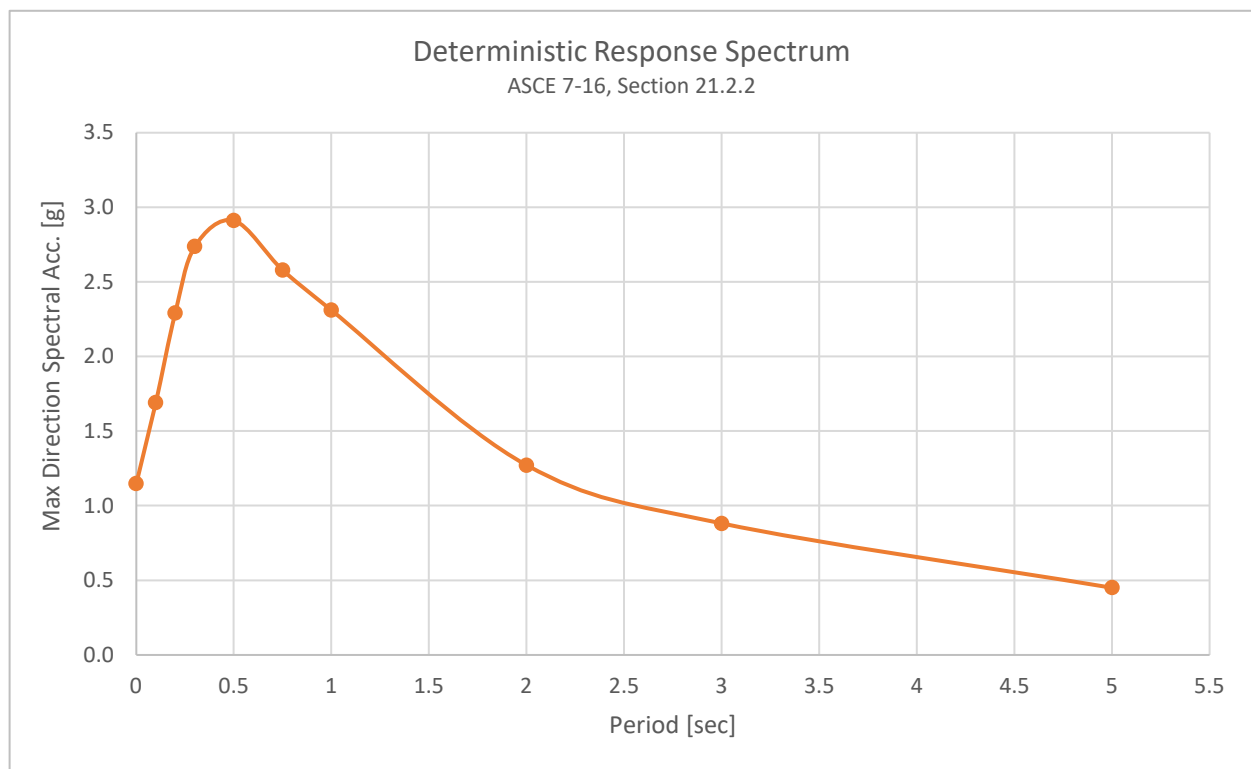

Site-Specific Design Ground Motions

Design Reference: ASCE 7-16, Sections 21.3 to 21.5

Job No.: 20-2653

Period, T [sec]	Max Probabilistic Spectral Acc. [g]	Max Deterministic Spectral Acc. [g]	MCE Spectral Response Acc. [g] ^a	2/3 MCE Spectral Response Acc. [g]	80% Code-based Design Spectrum	Site-Specific Design Acc. [g] ^b	Design Parameters
0	1.134	1.148	1.134	0.756	0.420	0.756	SD ₅
0.1	1.892	1.691	1.691	1.127	1.330	1.330	1.717
0.2	2.443	2.292	2.292	1.528	1.570	1.570	SD ₁
0.3	2.817	2.737	2.737	1.825	1.570	1.825	1.627
0.5	2.861	2.910	2.861	1.907	1.570	1.907	SM ₅
0.75	2.489	2.579	2.489	1.659	1.400	1.659	2.575
1	2.198	2.310	2.198	1.466	1.051	1.466	SM ₁
2	1.220	1.272	1.220	0.814	0.525	0.814	2.441
3	0.799	0.882	0.799	0.533	0.350	0.533	PGA
5	0.422	0.452	0.422	0.281	0.210	0.281	0.76

^a Equal to the lesser of the MCEr probabilistic and deterministic spectral acceleration at each ordinate

^b Equal to 2/3 of the MCE Spectral Response Acceleration

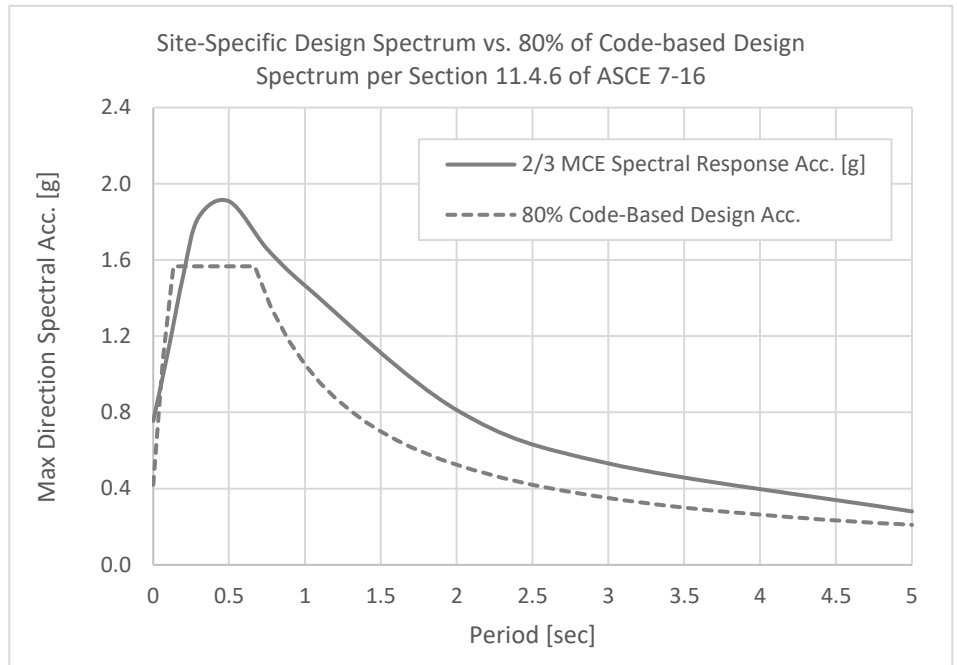
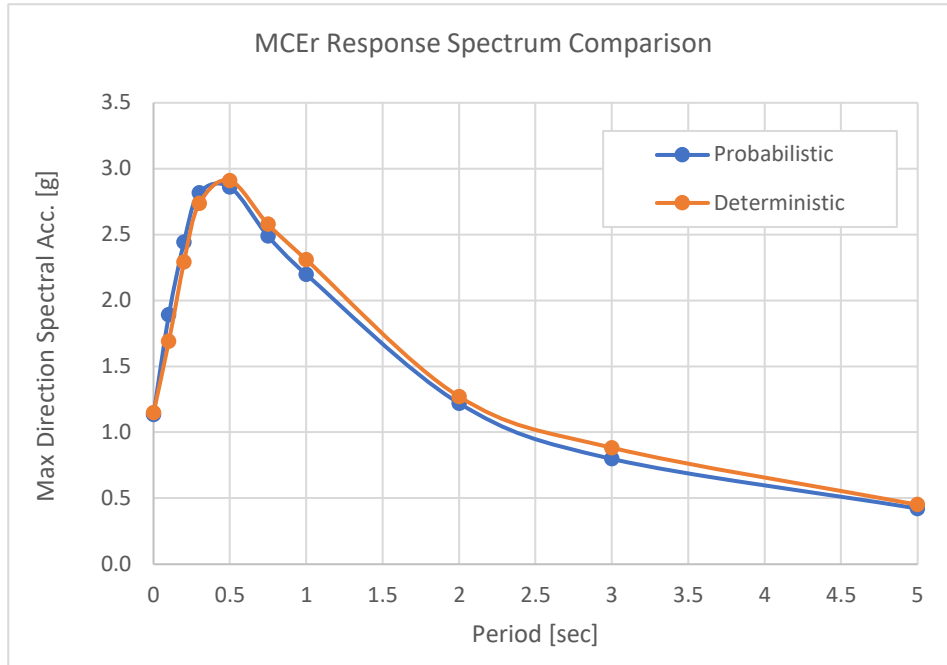

APPENDIX C

GROUND MOTION AND RESPONSE SPECTRA REFERENCES

- Abrahamson, N., Atkinson, G., Boore, D., Bozorgnia, Y., Campbell, K., Chiou, B., Idriss, I.M., Silva, W., Youngs, R., 2008, Comparisons of the NGA ground-motion relations: Earthquake Spectra, v. 24, no.1, p. 45–66.
- American Society of Civil Engineers, 2016, Minimum Design Loads and Associated Criteria for Buildings and Other Structures (ASCE/SEI 7-16), provisions and commentary.
- Boore, D.M., Stewart, J.P., Seyhan, E., and Atkinson, G.A., 2014, NGA-West2 equations for predicting PGA, PGV, and 5% damped PSA for shallow crustal earthquakes: Earthquake Spectra, v. 30, no. 3, p. 1057–1085.
- Campbell, K.W., and Bozorgnia, Y., 2014, NGA-West2 ground motion model for the average horizontal components of PGA, PGV, and 5% damped linear acceleration response spectra: Earthquake Spectra, v. 30, no. 3, p. 1087–1115.
- Chiou, B.S.-J. , and Youngs, R.R., 2014, Update of the Chiou and Youngs NGA model for the average horizontal component of peak ground motion and response spectra: Earthquake Spectra, v. 30, no. 3, p. 1117–1153.
- Field, E.H., Biasi, G.P., Bird, P., Dawson, T.E., Felzer, K.R., Jackson, D.D., Johnson, K.M., Jordan, T.H., Madden, C., Michael, A.J., Milner, K.R., Page, M.T., Parsons, T., Powers, P.M., Shaw, B.E., Thatcher, W.R., Weldon, R.J., II, and Zeng, Y., 2013, Uniform California earthquake rupture forecast, version 3 (UCERF3)—The time-independent model: U.S. Geological Survey Open-File Report 2013–1165, 97 p., California Geological Survey Special Report 228, and Southern California Earthquake Center Publication 1792, <http://pubs.usgs.gov/of/2013/1165/>
- Seyhan, E., (2015), Weighted Average of 2014 NGA West-2 GMPEs, Excel file: NGAW2_GMPE_Spreadsheets_v5.7_041515 (2015), Pacific Earthquake Engineering Research Center.
- Structural Engineers Association of California (SEAOC), OSHPD Seismic Design Maps web application, <https://seismicmaps.org/>
- U.S. Geological Survey, Beta – Unified Hazard Tool, Interactive Hazard Curve and Deaggregation web applications, <https://earthquake.usgs.gov/hazards/interactive/>
- U.S. Geological Survey, Quaternary Faults and Folds in the U.S., Google Earth .kmz file, <https://www.usgs.gov/natural-hazards/earthquake-hazards/google-earth-kml-files>
- U.S. Geological Survey, Risk-Targeted Ground Motion Calculator, <https://earthquake.usgs.gov/designmaps/rtgm/>
- U.S. Geological Survey, 2008 National Seismic Hazards Map – Source Parameters, https://earthquake.usgs.gov/cfusion/hazfaults_2008_search/query_main.cfm

Appendix D

SPT-Based Assessment of Seismic Soil Liquefaction Potential

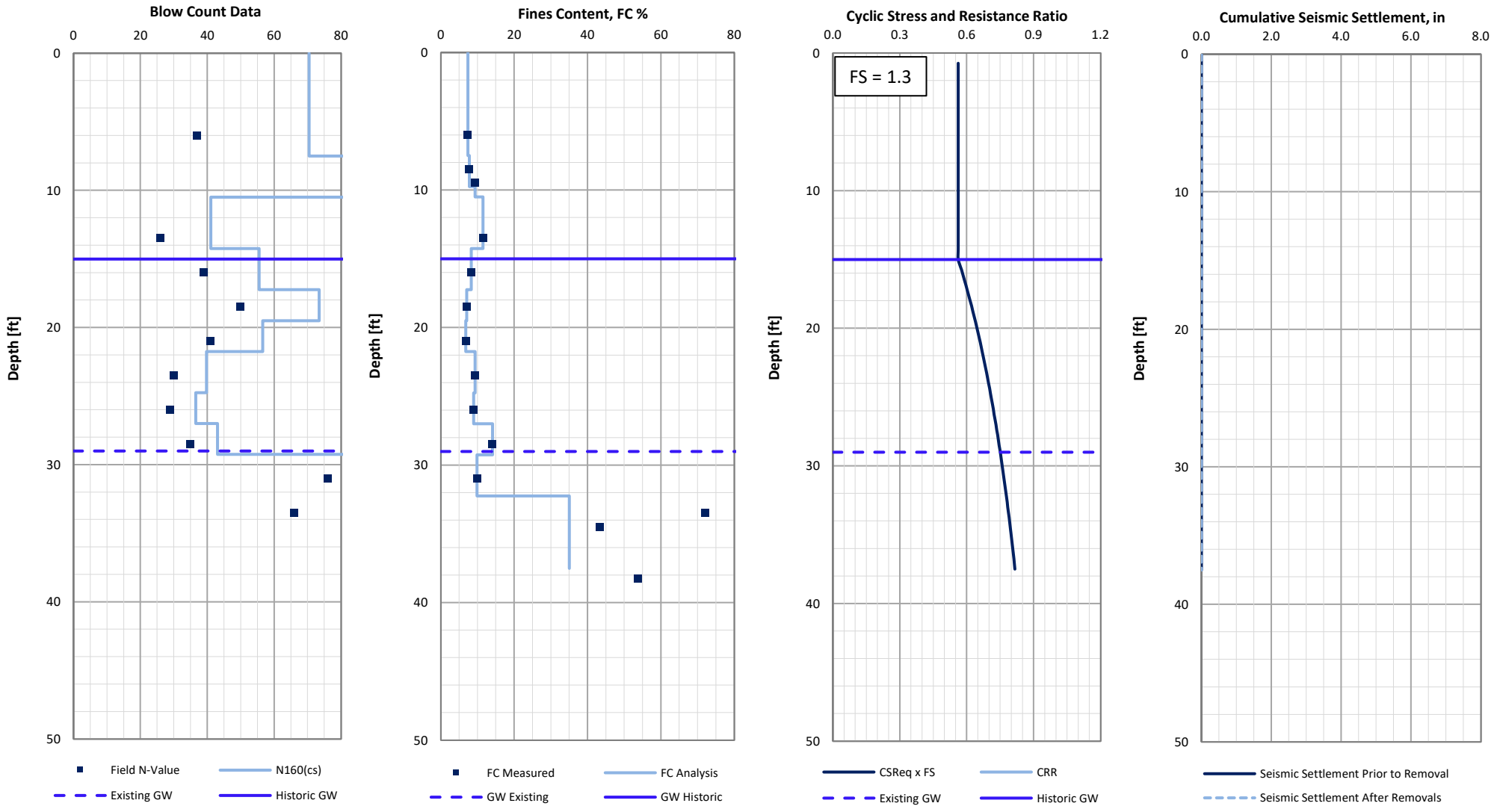

1. Design Reference: Cetin, et al., ASCE Journal of Geotechnical and Environmental Engineering, December 2004, pp. 1314 - 1340
2. Design Reference: Tokimatsu and Seed, ASCE Journal of Geotechnical Engineering, August 1987

Location:	HS-4
Elevation (MSL):	1423
Removal Depth (ft):	10
Total Settlement (in)	
<i>Prior to Removal:</i>	0.00
<i>After Removal:</i>	0.00

SPT Liq v1a; Feb 2017

Figure: D1

**ALLAN E. SEWARD
ENGINEERING GEOLOGY, INC.**
Geological and Geotechnical Consultants

Client: Union Rescue Mission
 Project: URM Hope Gardens
 Sequoia Building
 Job No.: 20-2653
 Date: 10/14/20

Magnitude, M_w 6.3
 Acceleration, PGA (g) 1.04
 Magnitude Weighted PGA (g) 0.66
 Existing GW Elev. (ft) 29
 Historic GW Elev. (ft) 15

Corrections for Standard Penetration Test

Design Reference: Cetin, et al., ASCE Journal of Geotechnical and Environmental Engineering, December 2004, pp. 1314 - 1340

Union Rescue Mission

Job No.: 20-2653

										Calculated By: K. Callahan		Date: 10/9/2020		
Layer	Sample Depth [ft]		Mid-Height Depth, z [ft]	USCS	Total Vertical Stress, σ_v [psf]	Pore Pressure, u [psf]	Effective Vertical Stress, σ'_v [psf]	Field Blow Count, N [blows/ft]	Overburden Correction Factor, C_N [lim ≤ 1.6]	Corrected Blow Count, N_1	Rod Length [ft]	Short Rod Length Correction Factor, C_R	Sampler Configuration Correction Factor, C_S [1.1 to 1.3]	Corrected Blow Count (N_1) ₆₀
	top	bottom			z_{VT}	$\sigma_v - u$	Cetin et al. (2004)		$N \times C_N$	Cetin et al. (2004)	$N_1 \times C_R \times C_S \times C_B \times C_E$			
1	5.5	6.5	6.0	SP-SM	720.0	0.0	720.0	37	1.60	59.2	9.5	0.75	1.00	68.1
2	8.0	9.0	8.5	SP-SM	1020.0	0.0	1020.0	88	1.44	126.8	12.0	0.80	1.00	155.5
3	9.5	9.5	9.5	SP-SM	1140.0	0.0	1140.0	100	1.36	136.2	13.5	0.85	1.00	177.6
4	13.0	14.0	13.5	SP-SM	1620.0	0.0	1620.0	26	1.14	29.7	17.0	0.85	1.00	38.7
5	15.5	16.5	16.0	SP-SM	1920.0	0.0	1920.0	39	1.05	40.9	19.5	0.85	1.00	53.4
6	18.0	19.0	18.5	SP-SM	2220.0	0.0	2220.0	50	0.98	48.8	22.0	0.95	1.00	71.1
7	20.5	21.5	21.0	SP-SM	2520.0	0.0	2520.0	41	0.92	37.6	24.5	0.95	1.00	54.7
8	23.0	24.0	23.5	SP-SM	2820.0	0.0	2820.0	30	0.87	26.0	27.0	0.95	1.00	37.9
9	25.5	26.5	26.0	SP-SM	3120.0	0.0	3120.0	29	0.82	23.9	29.5	0.95	1.00	34.8
10	28.0	29.0	28.5	SM	3420.0	0.0	3420.0	35	0.79	27.5	32.0	0.95	1.00	40.1
11	30.5	31.5	31.0	SP-SM	3720.0	124.8	3595.2	76	0.77	58.3	34.5	1.00	1.00	89.4
12	33.0	34.0	33.5	BEDROCK	4020.0	280.8	3739.2	66	0.75	49.7	37.0	1.00	1.00	76.1
13	34.5	34.5	34.5	BEDROCK	4140.0	343.2	3796.8	100	0.75	74.7	38.5	1.00	1.00	114.5
14	37.8	38.7	38.3	BEDROCK	4590.0	577.2	4012.8	100	0.73	72.6	41.8	1.00	1.00	111.4
15														
16														
17														
18														
19														
20														

Seismic Soil Liquefaction Triggering Calculations

Union Rescue Mission

Design Reference: Cetin, et al., ASCE Journal of Geotechnical and Environmental Engineering, December 2004, pp. 1314 - 1340

Job No.: 20-2653

												0.15 Probability of Liquefaction, P_L					
Layer	Depth, d [ft]	Corrected Blow Count (N_1) ₆₀	Fines Content, FC		C_{FINES} Eq. 15	Clean Sand Blow Count (N_1) _{60,CS} Eq. 14	Total Vertical Stress, σ_v [psf]	Pore Pressure, u [psf]	Effective Vertical Stress, σ'_v [psf]	Non-Linear Shear Factor, r_d (d<20m) Eq. 8	CSR_{eq} Eq. 10	Probability of Liquefaction, P_L Eq. 19	CRR for $P_L =$		τ (0.6-0.8) Eq. 18	$K\sigma$ Eq. 22	Factor of Safety, FS_L CRR/ CSR_{eq} *
			measured [%]	for analysis [%]									0.15 Eq. 20	σ Eq. 22			
1	0.8	68.1	7.4	7.4	1.04	70.5	90.0	0.0	90.0	1.000	0.68	0.00	4.00	0.80	1.00	0.43	>2.0
1	1.5	68.1	7.4	7.4	1.04	70.5	180.0	0.0	180.0	1.000	0.68	0.00	4.00	0.80	1.00	0.43	>2.0
1	2.3	68.1	7.4	7.4	1.04	70.5	270.0	0.0	270.0	1.000	0.68	0.00	4.00	0.80	1.00	0.43	>2.0
1	3.0	68.1	7.4	7.4	1.04	70.5	360.0	0.0	360.0	1.000	0.68	0.00	4.00	0.80	1.00	0.43	>2.0
1	3.8	68.1	7.4	7.4	1.04	70.5	450.0	0.0	450.0	1.000	0.68	0.00	4.00	0.80	1.00	0.43	>2.0
1	4.5	68.1	7.4	7.4	1.04	70.5	540.0	0.0	540.0	1.000	0.68	0.00	4.00	0.80	1.00	0.43	>2.0
1	5.3	68.1	7.4	7.4	1.04	70.5	630.0	0.0	630.0	1.000	0.68	0.00	4.00	0.80	1.00	0.43	>2.0
1	6.0	68.1	7.4	7.4	1.04	70.5	720.0	0.0	720.0	1.000	0.68	0.00	4.00	0.80	1.00	0.43	>2.0
1	6.8	68.1	7.4	7.4	1.04	70.5	810.0	0.0	810.0	1.000	0.68	0.00	4.00	0.80	1.00	0.43	>2.0
1	7.5	68.1	7.4	7.4	1.04	70.5	900.0	0.0	900.0	1.000	0.68	0.00	4.00	0.80	1.00	0.43	>2.0
2	8.3	155.5	7.8	7.8	1.03	160.7	990.0	0.0	990.0	1.000	0.68	0.00	4.00	0.80	1.00	0.43	>2.0
2	9.0	155.5	7.8	7.8	1.03	160.7	1080.0	0.0	1080.0	1.000	0.68	0.00	4.00	0.80	1.00	0.43	>2.0
2	9.8	155.5	7.8	7.8	1.03	160.7	1170.0	0.0	1170.0	1.000	0.68	0.00	4.00	0.80	1.00	0.43	>2.0
3	10.5	177.6	9.4	9.4	1.04	184.7	1260.0	0.0	1260.0	1.000	0.68	0.00	4.00	0.80	1.00	0.43	>2.0
4	11.3	38.7	11.5	11.5	1.06	41.1	1350.0	0.0	1350.0	1.000	0.68	0.00	4.00	0.80	1.00	0.43	>2.0
4	12.0	38.7	11.5	11.5	1.06	41.1	1440.0	0.0	1440.0	1.000	0.68	0.00	4.00	0.80	1.00	0.43	>2.0
4	12.8	38.7	11.5	11.5	1.06	41.1	1530.0	0.0	1530.0	1.000	0.68	0.00	4.00	0.80	1.00	0.43	>2.0
4	13.5	38.7	11.5	11.5	1.06	41.1	1620.0	0.0	1620.0	1.000	0.68	0.00	4.00	0.80	1.00	0.43	>2.0
4	14.3	38.7	11.5	11.5	1.06	41.1	1710.0	0.0	1710.0	1.000	0.68	0.00	4.00	0.80	1.00	0.43	>2.0
5	15.0	53.4	8.3	8.3	1.04	55.6	1800.0	0.0	1800.0	1.000	0.68	0.00	4.00	0.80	1.00	0.43	>2.0
5	15.8	53.4	8.3	8.3	1.04	55.6	1890.0	46.8	1843.2	1.000	0.69	0.00	4.00	0.80	1.00	0.44	>2.0
5	16.5	53.4	8.3	8.3	1.04	55.6	1980.0	93.6	1886.4	1.000	0.71	0.00	4.00	0.80	1.00	0.45	>2.0
5	17.3	53.4	8.3	8.3	1.04	55.6	2070.0	140.4	1929.6	1.000	0.73	0.00	4.00	0.80	1.00	0.46	>2.0
6	18.0	71.1	7.1	7.1	1.03	73.5	2160.0	187.2	1972.8	1.000	0.74	0.00	4.00	0.80	1.00	0.47	>2.0
6	18.8	71.1	7.1	7.1	1.03	73.5	2250.0	234.0	2016.0	1.000	0.75	0.00	4.00	0.80	1.00	0.48	>2.0
6	19.5	71.1	7.1	7.1	1.03	73.5	2340.0	280.8	2059.2	1.000	0.77	0.00	4.00	0.80	1.00	0.49	>2.0
7	20.3	54.7	6.8	6.8	1.03	56.6	2430.0	327.6	2102.4	1.000	0.78	0.00	4.00	0.80	1.00	0.50	>2.0
7	21.0	54.7	6.8	6.8	1.03	56.6	2520.0	374.4	2145.6	1.000	0.79	0.00	4.00	0.80	1.00	0.51	>2.0
7	21.8	54.7	6.8	6.8	1.03	56.6	2610.0	421.2	2188.8	1.000	0.81	0.00	4.00	0.80	1.00	0.52	>2.0
8	22.5	37.9	9.4	9.4	1.05	39.7	2700.0	468.0	2232.0	1.000	0.82	0.04	4.00	0.80	1.00	0.52	>2.0
8	23.3	37.9	9.4	9.4	1.05	39.7	2790.0	514.8	2275.2	1.000	0.83	0.05	4.00	0.80	1.00	0.53	>2.0
8	24.0	37.9	9.4	9.4	1.05	39.7	2880.0	561.6	2318.4	1.000	0.84	0.06	4.00	0.80	1.00	0.54	>2.0
8	24.8	37.9	9.4	9.4	1.05	39.7	2970.0	608.4	2361.6	1.000	0.85	0.07	4.00	0.80	1.00	0.54	>2.0
9	25.5	34.8	9.0	9.0	1.05	36.5	3060.0	655.2	2404.8	1.000	0.86	0.42	4.00	0.78	1.00	0.55	>2.0
9	26.3	34.8	9.0	9.0	1.05	36.5	3150.0	702.0	2448.0	1.000	0.87	0.45	4.00	0.78	1.00	0.56	>2.0
9	27.0	34.8	9.0	9.0	1.05	36.5	3240.0	748.8	2491.2	1.000	0.88	0.48	4.00	0.78	1.00	0.56	>2.0
10	27.8	40.1	14.1	14.1	1.07	43.1	3330.0	795.6	2534.4	1.000	0.89	0.01	4.00	0.80	1.00	0.57	>2.0
10	28.5	40.1	14.1	14.1	1.07	43.1	3420.0	842.4	2577.6	1.000	0.90	0.01	4.00	0.80	1.00	0.57	>2.0
10	29.3	40.1	14.1	14.1	1.07	43.1	3510.0	889.2	2620.8	1.000	0.90	0.01	4.00	0.80	1.00	0.58	>2.0
11	30.0	89.4	9.9	9.9	1.05	93.4	3600.0	936.0	2664.0	1.000	0.91	0.00	4.00	0.80	1.00	0.58	>2.0
11	30.8	89.4	9.9	9.9	1.05	93.4	3690.0	982.8	2707.2	0.999	0.92	0.00	4.00	0.80	1.00	0.59	>2.0

Seismic Soil Liquefaction Triggering Calculations

Design Reference: Cetin, et al., ASCE Journal of Geotechnical and Environmental Engineering, December 2004, pp. 1314 - 1340

Union Rescue Mission

Job No.: 20-2653

0.15 Probability of Liquefaction, P_L																	
Layer	Depth, d [ft]	Corrected Blow Count (N_1) ₆₀	Fines Content, FC		C_{FINES} Eq. 15	Clean Sand Blow Count (N_1) _{60,CS} Eq. 14	Total Vertical Stress, σ_v [psf]	Pore Pressure, u [psf]	Effective Vertical Stress, σ'_v [psf]	Non-Linear Shear Factor, r_d (d<20m) Eq. 8	CSR_{eq} Eq. 10	Probability of Liquefaction, P_L Eq. 19	CRR for $P_L =$		τ (0.6-0.8) Eq. 18	$K\sigma$ Eq. 22	Factor of Safety, FS_L CRR/ CSR_{eq} *
			measured [%]	for analysis [%]									0.15 Eq. 20	0.80 Eq. 20			
11	31.5	89.4	9.9	9.9	1.05	93.4	3780.0	1029.6	2750.4	0.999	0.93	0.00	4.00	0.80	1.00	0.59	>2.0
11	32.3	89.4	9.9	9.9	1.05	93.4	3870.0	1076.4	2793.6	0.999	0.94	0.00	4.00	0.80	1.00	0.60	>2.0
12	33.0	76.1	72.2	35.0	1.16	88.5	3960.0	1123.2	2836.8	0.999	0.94	0.00	4.00	0.80	1.00	0.60	>2.0
12	33.8	76.1	72.2	35.0	1.16	88.5	4050.0	1170.0	2880.0	0.999	0.95	0.00	4.00	0.80	1.00	0.61	>2.0
12	34.5	76.1	72.2	35.0	1.16	88.5	4140.0	1216.8	2923.2	0.999	0.96	0.00	4.00	0.80	1.00	0.61	>2.0
13	35.3	114.5	43.3	35.0	1.16	132.3	4230.0	1263.6	2966.4	0.999	0.96	0.00	4.00	0.80	1.00	0.62	>2.0
13	36.0	114.5	43.3	35.0	1.16	132.3	4320.0	1310.4	3009.6	0.999	0.97	0.00	4.00	0.80	1.00	0.62	>2.0
13	36.8	114.5	43.3	35.0	1.16	132.3	4410.0	1357.2	3052.8	0.999	0.98	0.00	4.00	0.80	1.00	0.62	>2.0
14	37.5	111.4	53.8	35.0	1.16	128.7	4500.0	1404.0	3096.0	0.999	0.98	0.00	4.00	0.80	1.00	0.63	>2.0

Seismically-Induced Settlement Calculations

Design Reference: Tokimatsu and Seed, ASCE Journal of Geotechnical Engineering, August 1987

Union Rescue Mission

Job No.: 20-2653

0.700 Vol. Strain Ratio For Dry Sands																	
Layer	Depth, d [ft]	Layer Thickness Δd [ft]	Avg. Clean Sand Blow Count (N ₁) _{60,CS}	Avg. CSR _{eq}	FS _L	Wet Settlement		Dry Sand Settlement									
						Volumetric Strain, ε _v [%]	Settlement [in]	a	b	Low Strain Shear Modulus G _{max} [psf]	Induced Cyclic Stress (Y _{eff} × G _{eff}) M=7.5 [ksf]	Y _{eff} × (G _{eff} / G _{max})	Cyclic Shear Strain, γ _{cyt} (Y _{eff} × 100) [%]	Volumetric Strain M = 7.5 [%]	Volumetric Strain M = 6.5 [%]	Volumetric Strain w/ 3D Effect [%]	Settlement [inches]
Cetin, 2004						Fig. 2	ε _v * Δd										
1	0.8	0.8	70	0.43	>2.0			0.66	2.31	640061	0.04	6.05E-05	0.01	0.00	0.00	0.01	
1	1.5	0.8	70	0.43	>2.0			0.68	2.22	905183	0.08	8.55E-05	0.02	0.01	0.00	0.01	
1	2.3	0.8	70	0.43	>2.0			0.69	2.16	1108618	0.12	1.05E-04	0.03	0.01	0.01	0.01	
1	3.0	0.8	70	0.43	>2.0			0.70	2.13	1280122	0.15	1.21E-04	0.03	0.01	0.01	0.02	
1	3.8	0.8	70	0.43	>2.0			0.70	2.10	1431220	0.19	1.35E-04	0.04	0.01	0.01	0.02	
1	4.5	0.8	70	0.43	>2.0			0.71	2.07	1567823	0.23	1.48E-04	0.04	0.02	0.01	0.02	
1	5.3	0.8	70	0.43	>2.0			0.71	2.06	1693442	0.27	1.60E-04	0.05	0.02	0.01	0.02	
1	6.0	0.8	70	0.43	>2.0			0.72	2.04	1810366	0.31	1.71E-04	0.05	0.02	0.01	0.03	
1	6.8	0.8	70	0.43	>2.0			0.72	2.03	1920183	0.35	1.81E-04	0.06	0.02	0.01	0.03	
1	7.5	0.8	70	0.43	>2.0			0.72	2.01	2024050	0.39	1.91E-04	0.06	0.02	0.01	0.03	
2	8.3	0.8	161	0.43	>2.0			0.72	2.00	2802164	0.43	1.52E-04	0.03	0.01	0.00	0.01	
2	9.0	0.8	161	0.43	>2.0			0.73	1.99	2926765	0.46	1.59E-04	0.04	0.01	0.00	0.01	
2	9.8	0.8	161	0.43	>2.0			0.73	1.98	3046274	0.50	1.65E-04	0.04	0.01	0.00	0.01	
3	10.5	0.8	185	0.43	>2.0			0.73	1.97	3311133	0.54	1.64E-04	0.04	0.00	0.00	0.01	0.00
4	11.3	0.8	41	0.43	>2.0			0.73	1.96	2074096	0.58	2.80E-04	0.11	0.07	0.05	0.10	0.00
4	12.0	0.8	41	0.43	>2.0			0.73	1.96	2142117	0.62	2.89E-04	0.12	0.07	0.05	0.10	0.00
4	12.8	0.8	41	0.43	>2.0			0.74	1.95	2208044	0.66	2.98E-04	0.12	0.07	0.05	0.10	0.00
4	13.5	0.8	41	0.43	>2.0			0.74	1.94	2272059	0.70	3.07E-04	0.12	0.08	0.05	0.11	0.00
4	14.3	0.8	41	0.43	>2.0			0.74	1.94	2334318	0.74	3.15E-04	0.13	0.08	0.05	0.11	0.00
5	15.0	0.8	56	0.43	>2.0			0.74	1.93	2657254	0.77	2.91E-04	0.10	0.05	0.03	0.06	0.00
5	15.8	0.8	56	0.44	>2.0	Non-liquefiable	0.00	0.74	1.93	2688952	0.81	3.02E-04	0.11	0.05	0.03	0.07	
5	16.5	0.8	56	0.45	>2.0	Non-liquefiable	0.00	0.74	1.93	2720280	0.85	3.12E-04	0.12	0.05	0.04	0.07	
5	17.3	0.8	56	0.46	>2.0	Non-liquefiable	0.00	0.74	1.92	2751252	0.89	3.23E-04	0.12	0.05	0.04	0.08	
6	18.0	0.8	73	0.47	>2.0	Non-liquefiable	0.00	0.74	1.92	3038901	0.93	3.05E-04	0.11	0.04	0.03	0.05	
6	18.8	0.8	73	0.48	>2.0	Non-liquefiable	0.00	0.74	1.92	3071993	0.97	3.15E-04	0.11	0.04	0.03	0.05	
6	19.5	0.8	73	0.49	>2.0	Non-liquefiable	0.00	0.74	1.92	3104733	1.01	3.25E-04	0.12	0.04	0.03	0.06	
7	20.3	0.8	57	0.50	>2.0	Non-liquefiable	0.00	0.74	1.91	2888795	1.05	3.64E-04	0.15	0.07	0.05	0.09	
7	21.0	0.8	57	0.51	>2.0	Non-liquefiable	0.00	0.75	1.91	2918323	1.09	3.75E-04	0.16	0.07	0.05	0.10	
7	21.8	0.8	57	0.52	>2.0	Non-liquefiable	0.00	0.75	1.91	2947556	1.14	3.86E-04	0.17	0.07	0.05	0.10	
8	22.5	0.8	40	0.52	>2.0	Non-liquefiable	0.00	0.75	1.91	2645054	1.16	4.39E-04	0.23	0.14	0.10	0.20	
8	23.3	0.8	40	0.53	>2.0	Non-liquefiable	0.00	0.75	1.90	2670528	1.21	4.52E-04	0.24	0.15	0.10	0.21	
8	24.0	0.8	40	0.54	>2.0	Non-liquefiable	0.00	0.75	1.90	2695762	1.25	4.64E-04	0.25	0.16	0.11	0.22	
8	24.8	0.8	40	0.54	>2.0	Non-liquefiable	0.00	0.75	1.90	2720762	1.28	4.69E-04	0.25	0.16	0.11	0.22	
9	25.5	0.8	36	0.55	>2.0	Non-liquefiable	0.00	0.75	1.90	2650784	1.32	4.99E-04	0.29	0.20	0.14	0.28	

Seismically-Induced Settlement Calculations

Design Reference: Tokimatsu and Seed, ASCE Journal of Geotechnical Engineering, August 1987

Union Rescue Mission

Job No.: 20-2653

0.700 Vol. Strain Ratio For Dry Sands

Layer	Depth, d [ft]	Layer Thickness Δd [ft]	Avg. Clean Sand Blow Count (N ₁) _{60,CS}	Avg. CSR _{eq}	FS _L	Wet Settlement		Dry Sand Settlement										
						Volumetric Strain, ε _v [%]	Settlement [in]	a	b	Low Strain Shear Modulus G _{max} [psf]	Induced Cyclic Stress (Y _{eff} × G _{eff}) M=7.5 [ksf]	Y _{eff} × (G _{eff} / G _{max})	Cyclic Shear Strain, γ _{cy} (γ _{eff} × 100) [%]	Volumetric Strain M = 7.5 [%]	Volumetric Strain M = 6.5 [%]	Volumetric Strain w/ 3D Effect [%]	Settlement [inches]	
Cetin, 2004						Fig. 2	ε _v *Δd											
9	26.3	0.8	36	0.56	>2.0	Non-liquefiable	0.00	0.75	1.90	2674488	1.37	5.13E-04	0.30	0.21	0.15	0.29		
9	27.0	0.8	36	0.56	>2.0	Non-liquefiable	0.00	0.75	1.89	2697983	1.40	5.17E-04	0.30	0.21	0.15	0.29		
10	27.8	0.8	43	0.57	>2.0	Non-liquefiable	0.00	0.75	1.89	2887317	1.44	5.00E-04	0.28	0.16	0.11	0.22		
10	28.5	0.8	43	0.57	>2.0	Non-liquefiable	0.00	0.75	1.89	2911821	1.47	5.05E-04	0.28	0.16	0.11	0.22		
10	29.3	0.8	43	0.58	>2.0	Non-liquefiable	0.00	0.75	1.89	2936120	1.52	5.18E-04	0.29	0.17	0.12	0.24		
11	30.0	0.8	93	0.58	>2.0	Non-liquefiable	0.00	0.75	1.89	3828208	1.55	4.04E-04	0.16	0.04	0.03	0.06		
11	30.8	0.8	93	0.59	>2.0	Non-liquefiable	0.00	0.75	1.88	3859122	1.60	4.14E-04	0.17	0.05	0.03	0.06		
11	31.5	0.8	93	0.59	>2.0	Non-liquefiable	0.00	0.75	1.88	3889791	1.62	4.17E-04	0.17	0.05	0.03	0.06		
11	32.3	0.8	93	0.60	>2.0	Non-liquefiable	0.00	0.75	1.88	3920220	1.68	4.28E-04	0.18	0.05	0.03	0.07		
12	33.0	0.8	89	0.60	>2.0	Non-liquefiable	0.00	0.75	1.88	3892946	1.70	4.37E-04	0.19	0.05	0.04	0.07		
12	33.8	0.8	89	0.61	>2.0	Non-liquefiable	0.00	0.75	1.88	3922476	1.76	4.48E-04	0.19	0.05	0.04	0.08		
12	34.5	0.8	89	0.61	>2.0	Non-liquefiable	0.00	0.75	1.88	3951785	1.78	4.51E-04	0.19	0.05	0.04	0.08		
13	35.3	0.8	132	0.62	>2.0	Non-liquefiable	0.00	0.75	1.87	4539837	1.84	4.05E-04	0.15	0.03	0.02	0.04		
13	36.0	0.8	132	0.62	>2.0	Non-liquefiable	0.00	0.75	1.87	4572774	1.87	4.08E-04	0.15	0.03	0.02	0.04		
13	36.8	0.8	132	0.62	>2.0	Non-liquefiable	0.00	0.76	1.87	4605476	1.89	4.11E-04	0.15	0.03	0.02	0.04		
14	37.5	0.8	129	0.63	>2.0	Non-liquefiable	0.00	0.76	1.87	4602542	1.95	4.24E-04	0.16	0.03	0.02	0.04		
Total Settlements [in]:							0.00											0.00

APPENDIX D

REFERENCES FOR ASSESSMENT OF LIQUEFACTION POTENTIAL AND ESTIMATED CYCLIC SETTLEMENTS

- Bartlett, S.F., and Youd, T.L., “Empirical prediction of liquefaction – induced lateral spread”, *Journal of Geotechnical Engineering*, Vol. 121, No. 4, April 1995.
- Boulanger, Ross W. and Idriss, I.M., “Liquefaction Susceptibility Criteria for Silts and Clays”, *ASCE Journal of Geotechnical and Geoenvironmental Engineering*, Vol. 132, No. 11, pp. 1413-1426, November, 2006.
- Bray, Jonathan D. and Sancio, Rodolfo B., “Assessment of the Liquefaction Potential of Fine Grained Soils”, *ASCE Journal of Geotechnical and Geoenvironmental Engineering*, Vol. 132, No. 9, pp. 1165-1177, September, 2006.
- California Division of Mines and Geology, Special Publication 117, “Guidelines for Evaluating and Mitigating Seismic Hazards in California”, adopted by the State on March 13, 1997.
- Douglas, B.J., and Olsen, R.S., “Soil classification using Electric Cone Penetrometer”, *ASCE Special Technical Publication*, ST. Louis, Missouri, October, 1981.
- Douglas, B.J., Olsen, R.S., and Martin, G.R., “Evaluation of the Cone Penetrometer Test for use in SPT—Liquefaction Potential Assessment,” *ASCE Preprint Volume No. 81-544*, St. Louis, Missouri, October 1981.
- Fear and McRoberts, “Reconsideration of initiation of liquefaction in sandy soils”, *ASCE Geotechnical Journal*, March 1995.
- Housner, G.W., Chairman of Committee on Earthquake Engineering, Book, “Liquefaction of soils during earthquakes”, p. 110-114, National Academy Press, 1985.
- Ishihara, K., “Soil Behaviour in Earthquake Geotechnics”, Clarendon Press, Oxford, 1996.
- Ishihara, K., “Stability of natural deposits during earthquakes”, *Proceedings of the Eleventh International Conference on Soil Mechanics and Foundation Engineering*, A.A. Balkema Publishers, Rotterdam, Netherlands, 1985
- Liao, S.S.C., and Whitman, R.V., “Overburden correction factors for SPT in sand”, *Journal of Geotechnical Engineering*, Vol. 112, No. 3, March 1986.
- Olsen, Richard S., “Cyclic Liquefaction Based on the Cone Penetrometer Test” in the *Proceedings of the NCEER Workshop on Evaluating the Liquefaction Resistance of Soils*, edited by Youd, T.L. and Idriss, I.M., Technical Report NCEER-97-0022, pp. 225-276, 1997
- Proprietary charts for correction of blow-count by sampler type to N-SPT
- Robertson, P. K., and Wride, C.F., “Cyclic Liquefaction and its Evaluation Based on the SPT and CPT” in the *Proceedings of the NCEER Workshop on Evaluating the Liquefaction Resistance of Soils*, edited by Youd, T.L. and Idriss, I.M., Technical Report NCEER-97-0022, pp. 41-87, 1997
- Robertson, P.K., and Fear, C.E., “Soil liquefaction and its evaluation based on SPT and CPT” *Liquefaction Workshop*, University of Alberta, January 1996.
- Robertson, P.K., and Fear, C.E., “Liquefaction of sands and its evaluation”, *First International Conference and Earthquake Geotechnical Engineering*, 1995.
- Robertson, P.K., and Campanella, R.G., “Guidelines for Geotechnical Design using the Cone Penetrometer Test and CPT with Pore Pressure Measurement”, University of Alberta and University of British Columbia, 4th edition, 1989.
- Seed, H.B., “Design problems in soil liquefaction,” Report No. UCB/EERC-86/02, February, 1986
- Seed, H.B., Tokimatsu, K., Harder, L.F., and Chung, R.M., “The influence of SPT procedures in soil liquefaction resistance evaluations”, *Earthquake Engineering Research Center Report No. 84/15*, University of California,

APPENDIX D

Berkeley, 1984.

Seed, H.B., Idriss, I.M., and Arango, I., "Evaluation of liquefaction potential using field performance data", ASCE Journal of Geotechnical Engineering, Vol. 109, No.3, March 1983.

Seed, H.B. and Idriss, I.M., "Ground motions and soil liquefaction during earthquakes", 1982, Monograph, Earthquake Engineering Research Institute.

Seed, H.B. and Idriss, I.M., "A simplified procedure for evaluating soil liquefaction potential", EERC 70-9, Nov. 1970.

Tokimatsu, K. and Seed, H.B., "Evaluation of settlements in sands due to earthquake shaking", ASCE Journal of Geotechnical Engineering, Vol. 113, No. 8, August, 1987.

University of Southern California (USC), Southern California Earthquake Center, Workshop on "Recommended Procedures for Implementation of DMG Special Publication 117, Guidelines for Analyzing and Mitigating Liquefaction in California", USC, Los Angeles, California, June 17, 1999.

Youd, T.L. and Idriss, I.M., editors, "Proceedings of the NCEER Workshop on Evaluation of Liquefaction Resistance of Soils", Technical Report NCEER-97-0022, December, 1997.

Youd, T.L., Idriss, I.M., et al "Liquefaction Resistance of Soils: Summary Report from the 1996 NCEER and 1998 NCEER/NSF Workshops on Evaluation of Liquefaction Resistance of Soils", Vol. 127, No. 10, ASCE Journal of Geotechnical and Geoenvironmental Engineering, October 2001.

Youd, T. Leslie, Hanson, Corbett M. and Bartlett, Steven F. "Revised Multilinear Regression Equations for Prediction of Lateral Spread Displacement", Vol. 128, No. 12, ASCE Journal of Geotechnical and Geoenvironmental Engineering, December 2002.

Appendix E

APPENDIX E

RECOMMENDED EARTHWORK SPECIFICATIONS

The following specifications are recommended to provide a basis for quality control during the placement of compacted fill or backfill, as applicable.

1. Areas on which compacted fill will be placed shall be observed by Allan E. Seward Engineering Geology, Inc. (AESEGI) prior to the placement of fill.
2. All drainage devices shall be properly installed and observed by AESEGI and/or the owner's representative(s) prior to placement of backfill.
3. Fill soils shall consist of imported soils or on-site soils which are free of organics, cobbles, and deleterious material, provided that each material is approved by AESEGI. AESEGI shall evaluate and/or test the import material for its conformance with the report recommendations prior to its delivery to the site. The contractor shall notify AESEGI at least 72 hours prior to importing material to the site.
4. The thickness of the controlled lifts in which Fill is placed shall be compatible with the type of compaction equipment used. The fill materials shall be brought to Optimum Moisture Content or above, thoroughly mixed during spreading to obtain a near uniform water content and a uniform blend of materials, and then placed in lifts with a pre-compaction thickness not exceeding 8 inches. Each lift shall be compacted to the specified percentage of Maximum Dry Density determined in accordance with ASTM Test Method D1557. Density testing shall be performed by AESEGI to verify relative compaction. The contractor shall provide proper access and level areas for testing.
5. Rocks or rock fragments less than eight (8) inches in the largest dimension may be utilized in the fill, provided they are not placed in concentrated pockets. However, rocks larger than four (4) inches in dimension shall not be placed within three (3) ft of finish grade.
6. Rocks greater than eight (8) inches in largest dimension shall be taken offsite, or placed in areas designated by the Geotechnical Engineer to be suitable for rock disposal.
7. Where space limitations do not allow for conventional fill compaction operations, special backfill materials and procedures may be required. Pea gravel or other select fill can be used in areas of limited space. A sand and Portland Cement slurry (2 sacks per cubic-yard of slurry mix) shall be used in limited space areas for shallow backfill near final pad grade, and pea gravel shall be placed in deeper backfill near drainage systems.
8. AESEGI shall observe the placement of fill and conduct in-place field density tests on the compacted fill in order to check adequacy of in-situ water content and relative compaction.

APPENDIX E

Where measured in-situ density of compacted fill soil is lower than the required relative compaction, the soil shall be water-conditioned and recompacted until adequate relative compaction is achieved.

9. The Contractor shall achieve with the specified relative compaction out to the finish slope face of fill slopes, buttresses, and stabilization fills, as set forth in the specifications for compacted fill. This may be achieved either by overbuilding the slope and cutting back as necessary, by direct compaction of the slope face with suitable equipment, or by other procedures which produce the required result.
10. Any abandoned underground structures such as cesspools, cisterns, mining shafts, tunnels, septic tanks, wells, pipelines, or others not discovered prior to grading are to be removed or treated to the satisfaction of the Geotechnical Engineer and/or the controlling agency for the project.
11. The Contractor shall have suitable and sufficient equipment during a particular operation to handle the volume of fill being placed. When necessary, fill placement equipment shall be shut down temporarily in order to permit proper compaction of fill, correction of deficient areas, or to facilitate required field testing.
12. The Contractor shall be responsible for the satisfactory completion of all earthwork in accordance with the project plans and specifications.
13. Final reports shall be submitted after completion of earthwork and after the Geotechnical Engineer and Engineering Geologist have finished their observations of the work. No additional excavation or filling shall be performed without prior notification to the Geotechnical Engineer and/or Engineering Geologist.
14. Whenever the words “supervision”, “inspection”, or “control” are used, they shall mean observation of the work and/or testing of the compacted fill by AESEGI to assess whether substantial compliance with plans, specifications and design concepts has been achieved. However, these words do not refer to direction by AESEGI of the actual work of the Contractor or the Contractor’s workers.

APPENDIX E

RECOMMENDED SPECIFICATIONS FOR PLACEMENT OF TRENCH BACKFILL

1. Trench excavations in which backfill will be placed shall be free of trash, debris or other deleterious materials prior to backfill placement, and shall be observed by a representative of Allan E. Seward Engineering Geology, Inc. (AESEGI).
2. Except as stipulated herein, soils obtained from the excavation may be used as backfill if they are free of organics and other deleterious materials.
3. Rocks generated by trench excavation operations that do not exceed three (3) inches in largest dimension may be used as trench backfill material. However, material larger than 3-inches in dimension may not be placed within 12 inches of the top of pipes. No more than 30 percent of the backfill volume shall contain particles larger than 1-½ inches in dimension, and particles larger than 1-½ inches in dimension shall be well mixed with finer soil.
4. Clean aggregates with a Sand Equivalent (SE) greater than or equal to 30 (as determined by ASTM Standard Test Method D2419) or other soils authorized by the Geotechnical Engineer or his representative in the field, may be used for bedding and shading material in pipe trenches.
5. Trench backfill other than bedding and shading shall be compacted by mechanical methods as tamping sheepsfoot, vibrating or pneumatic rollers, or other mechanical tampers to achieve the specified density. The backfill materials shall be brought to Optimum Moisture Content or above, thoroughly mixed during spreading to obtain a near uniform water content and uniform blend of materials, and then placed in horizontal lifts with a pre-compaction thickness not exceeding 8 inches. Trench backfills shall be compacted to the specified percentage of Maximum Dry Density determined in accordance with ASTM Test Method D1557.
6. The Contractor shall select the equipment and procedure for achieving the specified density without damage to the pipe, the adjacent ground, existing improvements, or completed work.
7. Observations and field tests shall be performed during construction by AESEGI to confirm that the required degree of compaction has been achieved. Where achieved compaction is less than that specified value, the water content shall be adjusted as necessary and additional compactive effort shall be made until the specified compaction is achieved. Field density tests may be omitted at the discretion of the Geotechnical Engineer or his

APPENDIX E

representative in the field.

8. Whenever, in the opinion of AESEGI or the Owner's Representative(s), an unstable condition is being created either by cutting or filling, the work shall not proceed until an investigation has been made and the excavation plan has been revised, if deemed necessary.
9. Fill material shall not be placed, spread, or rolled during unfavorable weather conditions. When the work is interrupted by heavy rain, fill operations shall not be resumed until field tests by AESEGI indicate the water content and density of the fill materials and of the fill surface over which they are to be compacted satisfy the requirements of the specifications.
10. Whenever the words "supervision", "inspection", or "control" are used, they shall mean observation of the work and/or testing of the compacted fill by AESEGI to assess whether substantial compliance with plans, specifications and design concepts has been achieved.

APPENDIX E

DRAINAGE AND EROSION CONTROL RECOMMENDATIONS

Slopes and pads for this project shall be designed to direct surficial runoff away from structures and to reduce water-induced surficial erosion/sloughing. Permanent erosion control measures shall be initiated immediately following completion of grading. All constructed slopes will undergo some erosion when subjected to sustained water influx. To maintain appropriate long-term drainage and erosion control, the following points shall be incorporated in slope protection, landscaping, irrigation, and modifications to slopes, pads and structures:

1. All interceptor ditches, drainage terraces, down-drains and any other drainage devices shall be maintained and kept clear of debris. A qualified Engineer should review any proposed additions or revisions to these systems in order to evaluate their impact on slope erosion.
2. Retaining walls shall have adequate freeboard to provide a catchment area for minor slope erosion. Periodic inspection, and if necessary, cleanout of deposited soil and debris shall be performed, particularly during and after periods of rainfall.
3. The future developers shall be made aware of the **potential problems**, which may develop **when drainage is altered** by landscaping and/or by construction of retaining walls and paved walkways. Pondered water, water directed over slope faces, leaking irrigation systems, **over-watering**, or other conditions which could lead to excessive soil moisture, **must be avoided**.
4. Surficial slope soils may be subject to water-induced mass erosion. Therefore, a suitable proportion of slope planting shall have root systems which will extend well below three feet. We suggest consideration of drought-resistant shrubs and low trees for this purpose. Intervening areas can then be planted with lightweight surface plants with shallower root systems. All plants shall be lightweight and require low moisture. Any loose slough generated during planting of shrubs, trees, and other surface plants shall be removed from slope faces.
5. Construction delays, climate/weather conditions, and plant growth rates may necessitate additional short-term, non-plant erosion control measures such as matting, netting, plastic sheets, deep (5-ft) staking, etc.
6. Significant erosion can be initiated by seemingly insignificant events such as rodent burrowing, human trespass (footprints, etc.), small concentrations of uncontrolled surface/subsurface water, or poor compaction of utility trench backfill on slopes.
7. High and/or fluctuating water content in slope materials is a major factor in slope erosion

APPENDIX E

and/or slope failures. Therefore, all possible precautions shall be taken to maintain moderate and uniform soil moisture in soil and rock slopes. Slope irrigation systems shall be properly operated and maintained and irrigation system controls shall be placed under strict control.

EROSION CONTROL REFERENCES

1. "Slope Protection for Residential Developments", National Academy of Sciences, Washington D.C. (1969).
2. "Guide for Erosion and Debris Control in Hillside Areas", Department of Building and Safety, City of Los Angeles. (1970).
3. "Slope Stability Report", Orange County Department of Building and Safety (1973).
4. "Guides for Erosion and Sediment Control", Soil Conservation Service, Davis, California, U.S. Department of Agriculture (1977).
5. "Rain-Care and Protection of Hillside Homes", brochure undated, published by Building and Safety Division, Los Angeles County Engineer.
6. "Guidelines for Erosion and Sediment Control Planning and Implementation: Office of Research and Monitoring", U.S. Environmental Protection Agency (1972).
7. "Resource Conservation Glossary", Soil Conservation Society of America (1970).
8. "Standards and Specifications for Soil Erosion and Sediment Control Developing Areas", Soil Conservation Service, U.S. Department of Agriculture (1975).
9. "Homeowners Guide for Debris and Erosion Control", Los Angeles County Flood Control District (undated).
10. "Grading Guidelines (8 pages, stapled sheets)", Building and Safety Division, Department of County Engineer, County of Los Angeles (undated, but probably about 1977).
11. "Biotechnical Slope Protection and Erosion Control", Donald H. Gray and Andrew T. Leiser, Robert E. Krieger Publishing Company, Malabuv, Florida, 1989.

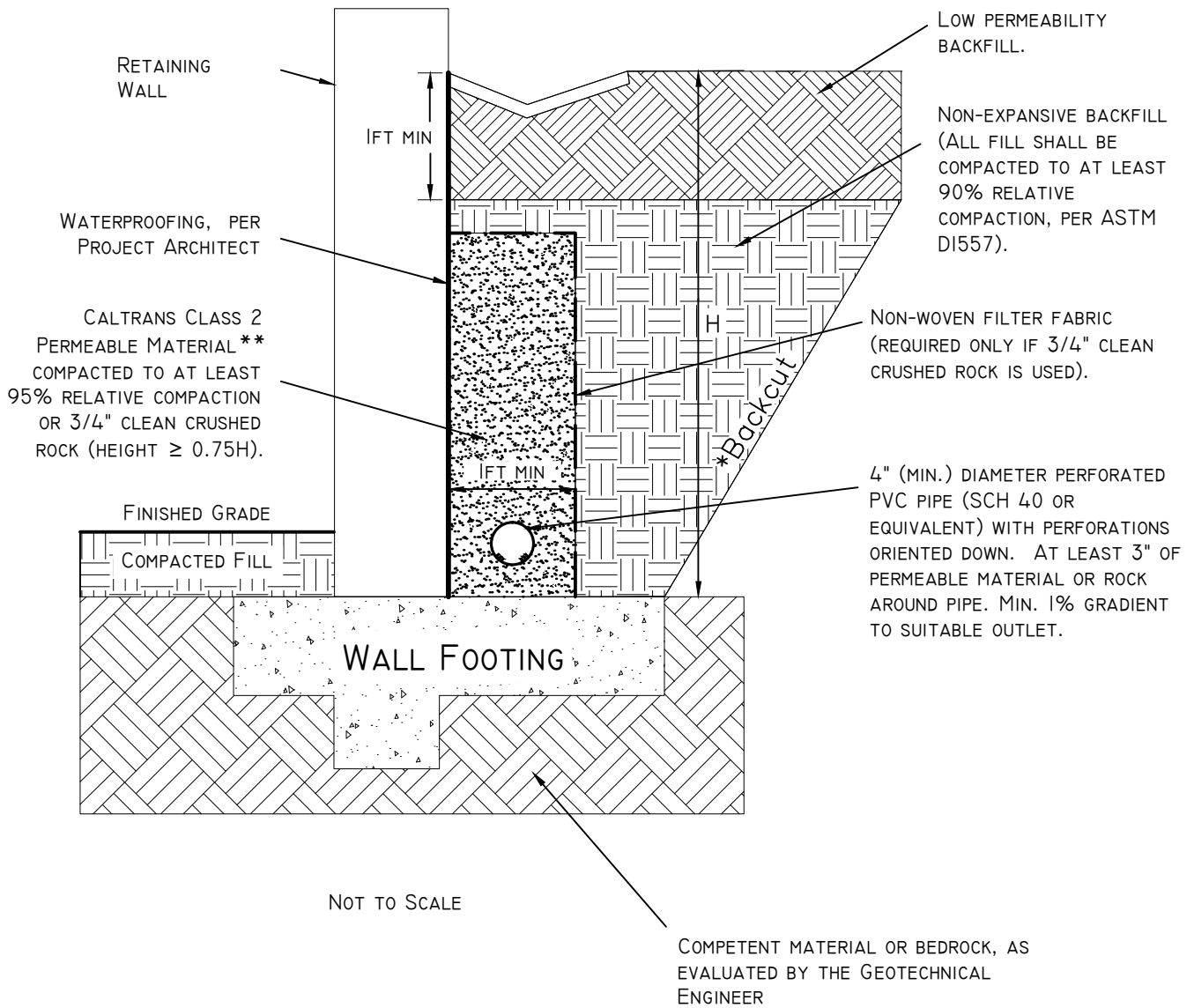

****SPECIFICATIONS FOR CALTRANS CLASS 2 PERMEABLE MATERIAL**

U.S. STANDARD SIEVE SIZE	% PASSING
1"	100
3/4"	90-100
3/8"	40-100
No. 4	25-40
No. 8	18-33
No. 30	5-15
No. 50	0-7
No. 200	0-3

SAND EQUIVALENT >75

* ALL BACKCUTS SHALL BE IN ACCORDANCE WITH OSHA STANDARDS, UNLESS SITE-SPECIFIC BACKCUT AND BACKFILL RECOMMENDATIONS ARE MADE BY THIS OFFICE.



**ALLAN E. SEWARD
ENGINEERING GEOLOGY, INC.**
Geologic and Geotechnical Consultants

RETAINING WALL DRAINAGE DETAIL

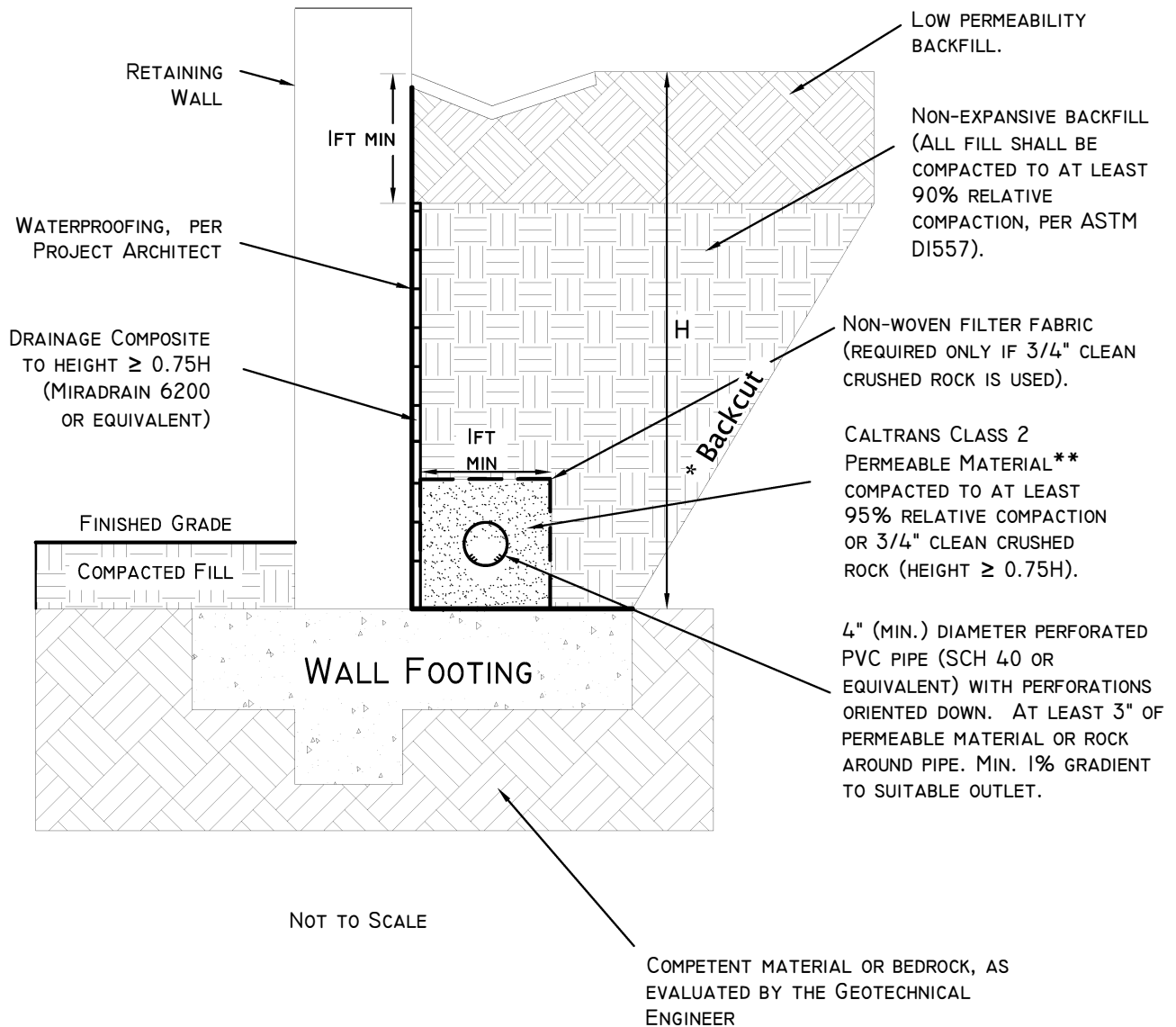

****SPECIFICATIONS FOR CALTRANS CLASS 2 PERMEABLE MATERIAL**

U.S. STANDARD SIEVE SIZE	% PASSING
1"	100
3/4"	90-100
3/8"	40-100
No. 4	25-40
No. 8	18-33
No. 30	5-15
No. 50	0-7
No. 200	0-3

SAND EQUIVALENT >75

* ALL BACKCUTS SHALL BE IN ACCORDANCE WITH OSHA STANDARDS, UNLESS SITE-SPECIFIC BACKCUT AND BACKFILL RECOMMENDATIONS ARE MADE BY THIS OFFICE.



ALLAN E. SEWARD
ENGINEERING GEOLOGY, INC.
 Geologic and Geotechnical Consultants

**ALTERNATE RETAINING WALL
 DRAINAGE DETAIL**

LEGEND

- af Artificial Fill
- Qal ALLUVIUM
- af/Qal ARTIFICIAL FILL/ALLUVIUM UNDIFFERENTIATED
- TQs SAUGUS FORMATION BEDROCK
- Geologic Contact
- Cross Section
- HS-5 Hollow-stem Auger Boring
- PB-2 Percolation Boring
- R=10 Recommended Removal and Recompaction
- Removal Limits for Proposed Building

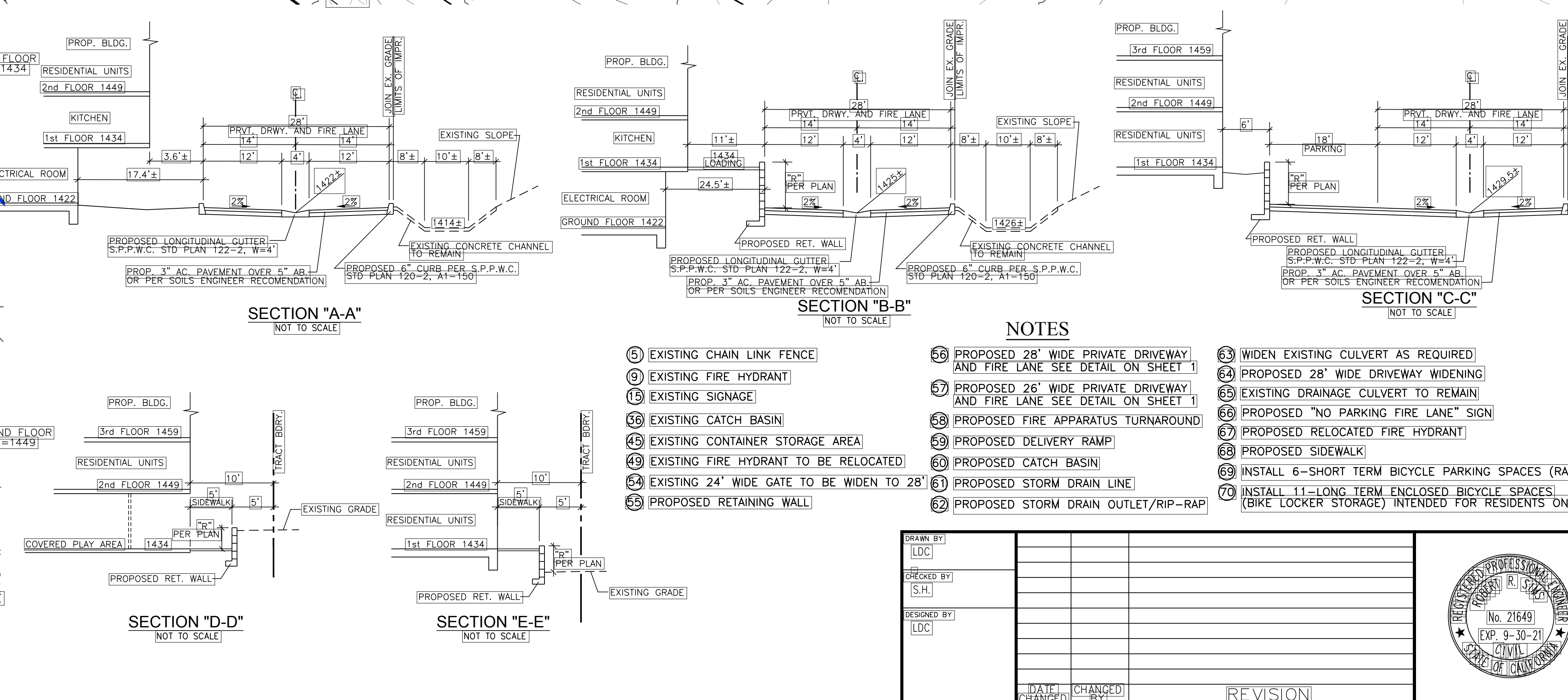
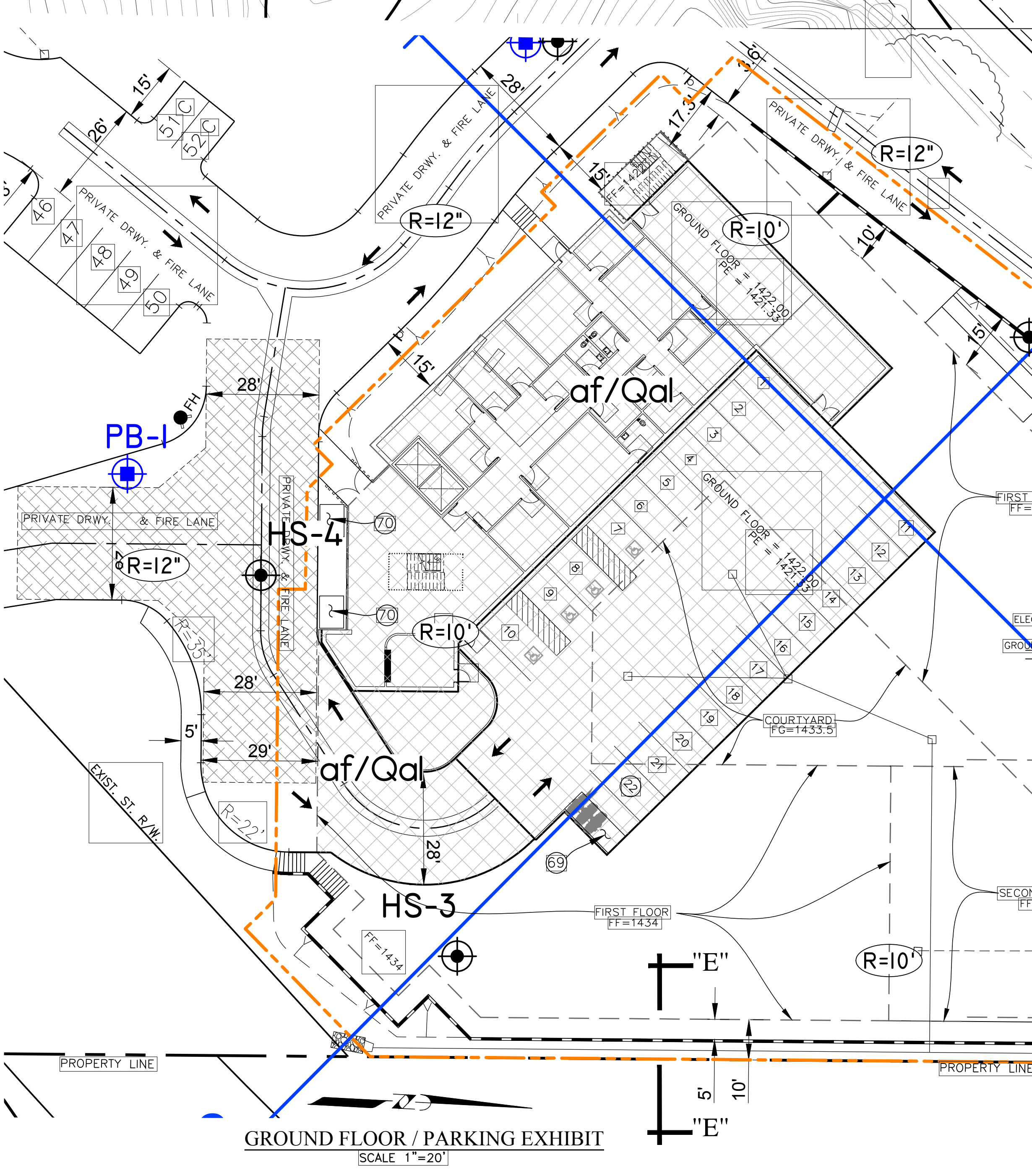
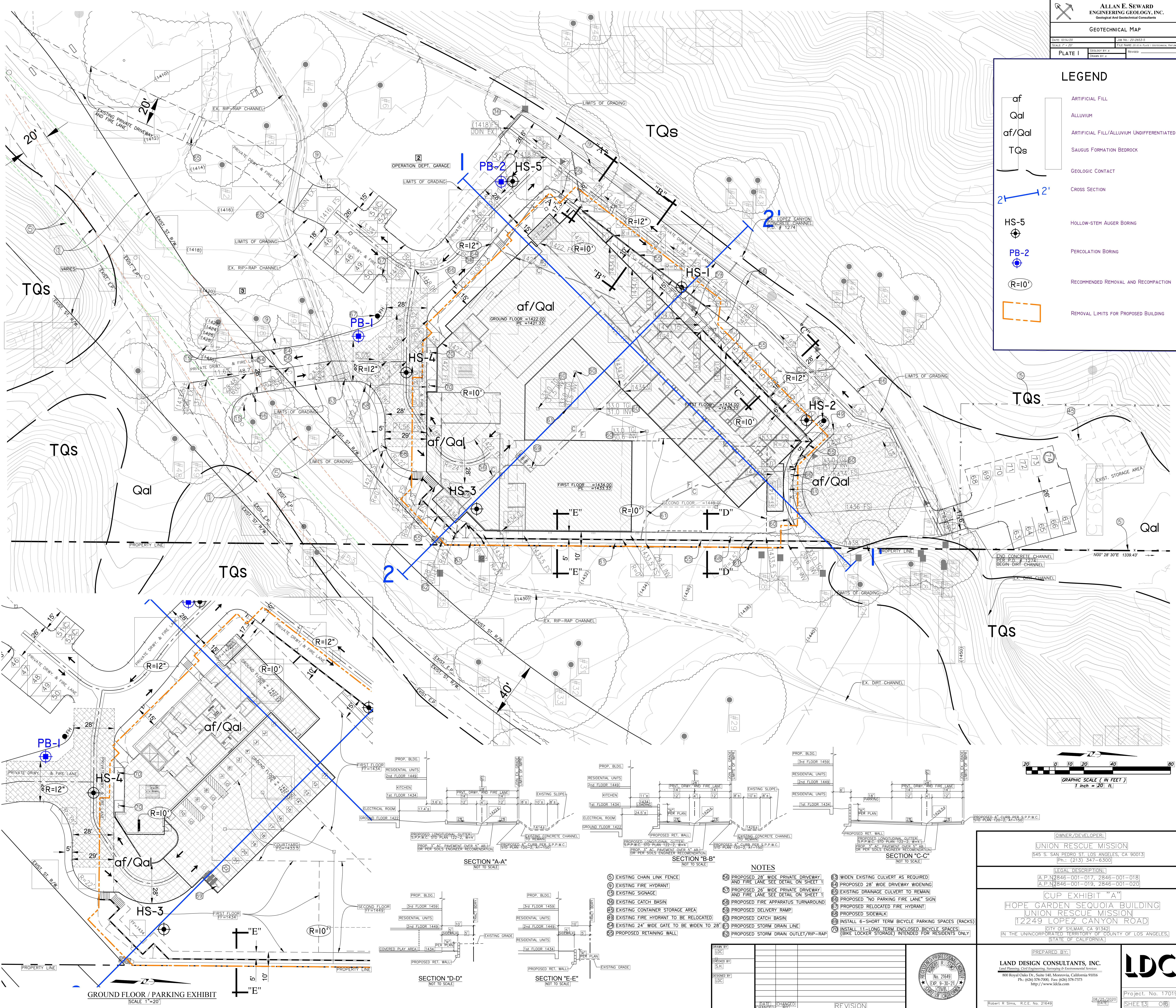

- NOTES**
- EXISTING CHAIN LINK FENCE
 - EXISTING FIRE HYDRANT
 - EXISTING SIGNAGE
 - EXISTING CATCH BASIN
 - EXISTING CONTAINER STORAGE AREA
 - EXISTING FIRE HYDRANT TO BE RELOCATED
 - EXISTING 24" WIDE GATE TO BE WIDEN TO 28"
 - PROPOSED RETAINING WALL
 - PROPOSED 28" WIDE PRIVATE DRIVEWAY AND FIRE LANE SEE DETAIL ON SHEET 1
 - EXISTING SIGNAGE
 - PROPOSED FIRE APPARATUS TURNAROUND
 - PROPOSED DELIVERY RAMP
 - PROPOSED CATCH BASIN
 - PROPOSED STORM DRAIN LINE
 - PROPOSED STORM DRAIN OUTLET/RIP-RAP
 - WIDEN EXISTING CULVERT AS REQUIRED
 - PROPOSED 28" WIDE DRIVEWAY WIDENING
 - EXISTING DRAINAGE CULVERT TO REMAIN
 - PROPOSED "NO PARKING FIRE LANE" SIGN
 - PROPOSED RELOCATED FIRE HYDRANT
 - PROPOSED SIDEWALK
 - INSTALL 6-SHORT TERM BICYCLE PARKING SPACES (RACKS)
 - INSTALL 11-LONG TERM ENCLOSED BICYCLE SPACES (BIKE LOCKER STORAGE) INTENDED FOR RESIDENTS ONLY

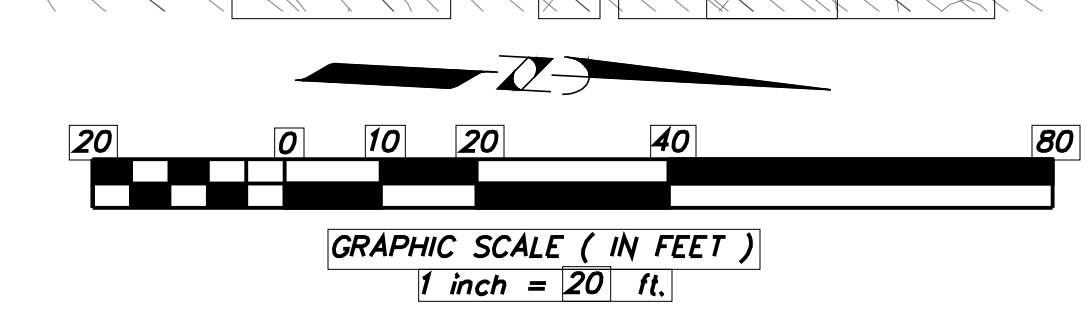

OWNER/DEVELOPER:
UNION RESCUE MISSION
545 S. SAN PEDRO ST. LOS ANGELES, CA 90013
(Ph.: (213) 347-6300)

LEGAL DESCRIPTION:
A.P.N. 2846-001-017, 2846-001-018
A.P.N. 2846-001-019, 2846-001-020

CUP EXHIBIT "A"
HOPE GARDEN SEQUOIA BUILDING
UNION RESCUE MISSION
12249 LOPEZ CANYON ROAD
CITY OF SYLMAR, CA 91342
(IN THE UNINCORPORATED TERRITORY OF COUNTY OF LOS ANGELES, STATE OF CALIFORNIA.)

PREPARED BY:
LAND DESIGN CONSULTANTS, INC.
Land Planning, Civil Engineering, Surveying & Environmental Services
800 Royal Oaks Dr., Suite 140, Menlo Park, California 94016
Ph. (650) 576-7000, Fax (650) 576-7373
http://www.ldca.com

LDC
Project No. 17019-005
08/25/2020 DATE SHEET 13 OF 13

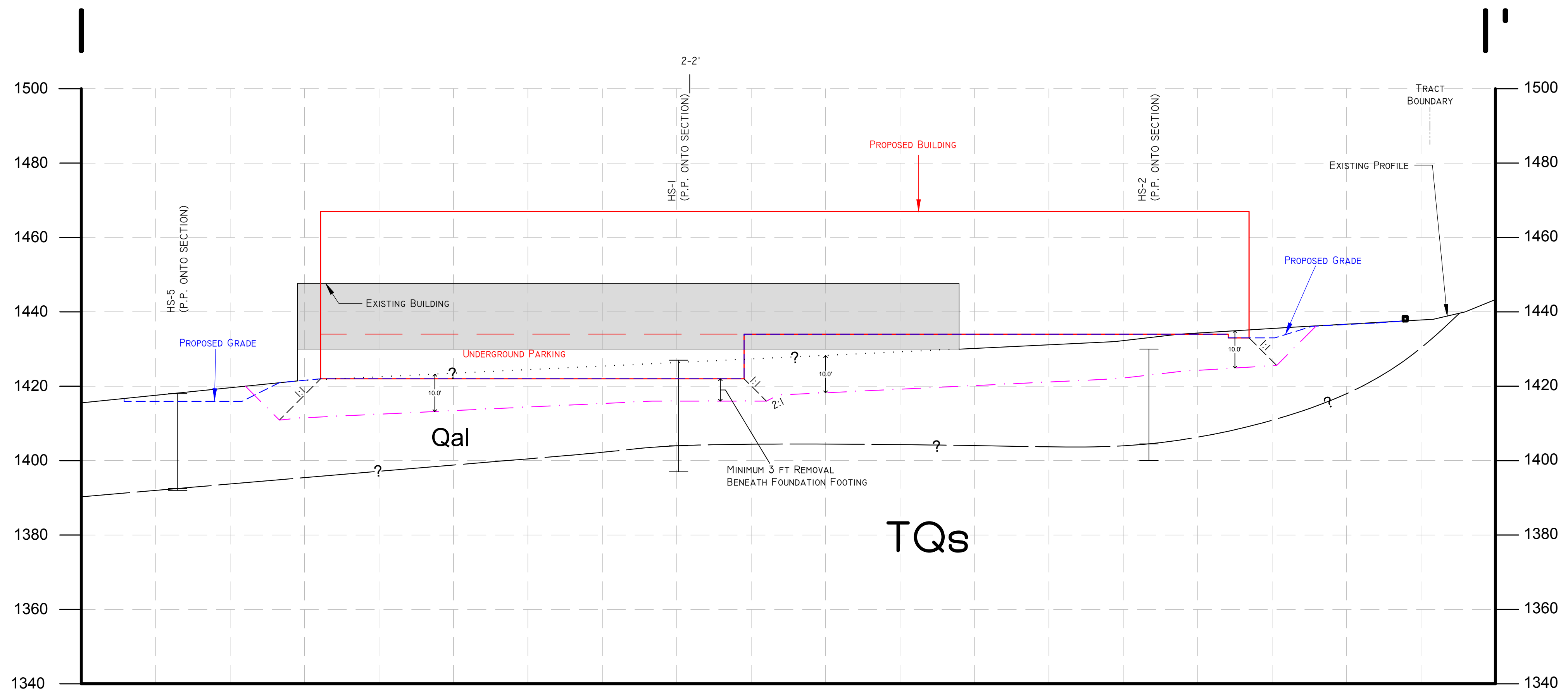

N42E

2

2'

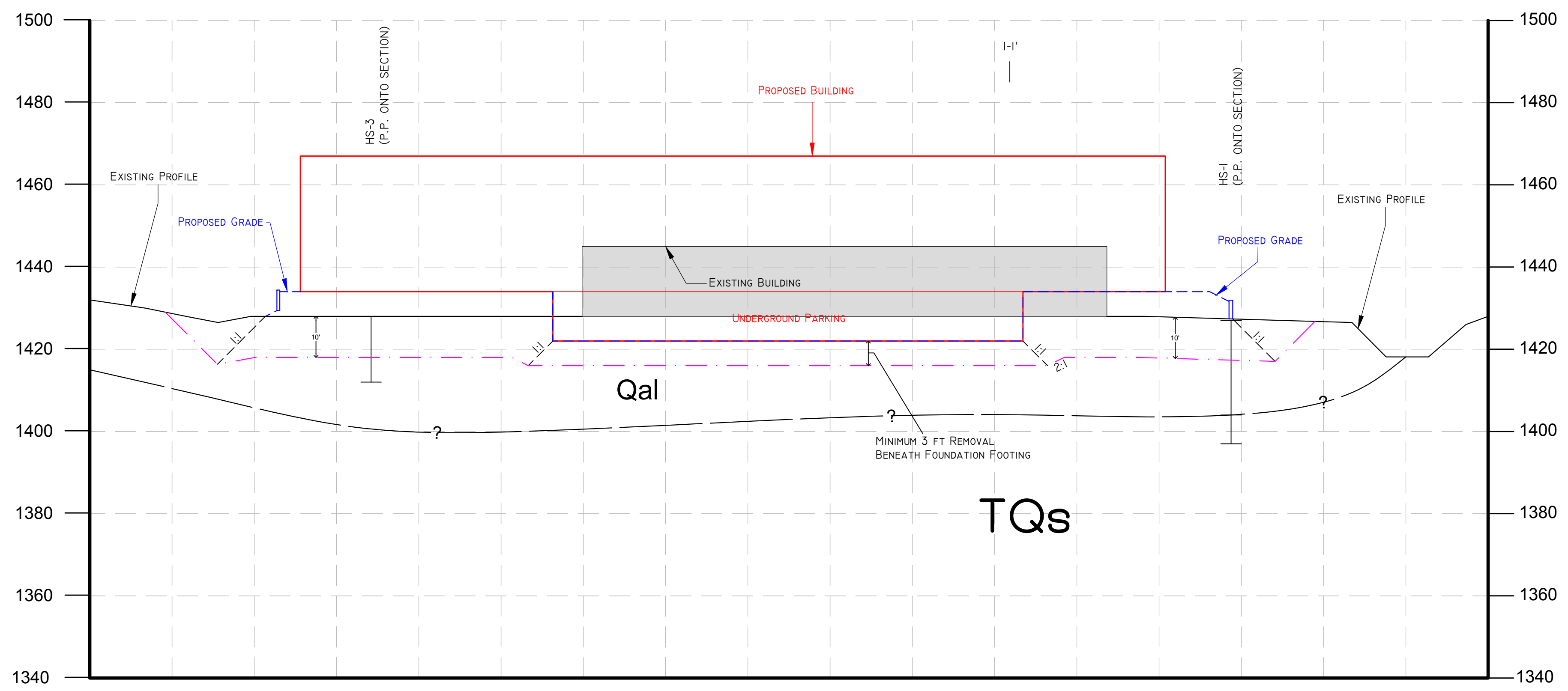

N48W

 ALLAN E. SEWARD ENGINEERING GEOLOGY, INC. Geological And Geotechnical Consultants	
CROSS SECTIONS 1-1' & 2-2'	
DATE: 10/14/20	JOB No.: 20-2653-5
SCALE: 1" = 20'	FILE NAME: XS PLATE LAYOUT
PLATE II	GEOLGY BY: X DRAWN BY: X
REVISED: _____	